

Alma Mater Studiorum – Università di Bologna

DOTTORATO DI RICERCA IN
INGEGNERIA CHIMICA, DELL'AMBIENTE E DELLA
SICUREZZA

Ciclo XXVIII

Settore Concorsuale di afferenza: 03/D–Farmaceutico, Tecnologico,
Alimentare

Settore Scientifico disciplinare: CHIM/11-Chimica e Biotecnologia delle
Fermentazioni

DEVELOPMENT OF BIOREFINERY SCHEMES FOR THE
VALORIZATION OF AGRO-INDUSTRIAL WASTES: *PRODUCTION
OF POLYHYDROXYALKANOATES*

Presentata da: Gonzalo Agustín Martínez

Coordinatore Dottorato

Relatore

Prof. Serena Bandini

Prof. Fabio Fava

Esame finale anno 2016

ACKNOWLEDGEMENTS

First of all I would like to thank my family for supporting me. In this regard, I will be always very grateful indeed to my mother who gave all she can for educating me; teaching me the ideas of justice, willingness to learn and hardworking for trying to obtain what desired.

Secondly, my sincere gratitude to my tutors Prof. Lorenzo Bertin and Prof. Fabio Fava, for giving me the opportunity to make the PhD on bioprocesses at their group, for their advices and recommendations. In this las regard, I am also grateful to Prof. Braunegg. Special thanks to PhD. Alberto Scoma with whom I start working in the lab, on biopolymers production; a new research field for the group in 2012. I would like also to extend special thanks to Prof. Bandini, who guided me on my first steps on acids separation with membranes.

To my colleagues Joana M. B. Domingos, Stefano Rebecchi and Andrea Negroni with whom we discuss about work and life, they also actively collaborates and support me during the hard and long experiments. Even more important, thank you very much indeed for your friendship. Also thanks to Valentina Morelli who sheared me her bench-pilot nanofiltration plant for carrying out the acid separation experiments.

Finally, I would like to gratefully acknowledge the projects Water for Crops and PRIN for the grants during these three years.

ABSTRACT

Aiming to reduce the cost of production of polyhydroxyalkanoates (PHAs), it was verified the use of two agro-industrial wastes as alternatives carbon sources for the production of:

- A- poly(hydroxybutyrate-co-hydroxyvalerate), from olive mill wastewater (2012 campaign; 60% dephenolised). It was possible to used up to 25% v/v in the culture media due to the presence of polyphenolic inhibitors in the matrix.
- B- polyhydroxybutyrate (PHB) with OMW belonging to 2013 (>70% dephenolised): the culture medium could contain 100% v/v without causing inhibition. An integrated biorefinery scheme was defined and tested sequentially: polyphenols recovery, organic acids PHAs and biogas production.
- C- PHB from dephenolised and fermented grape pomace. An integrated biorefinery scheme was proposed for the first time for the valorisation of grape pomace.
- D- medium chain length polyhydroxyalkanoates by performing the anaerobic acidogenic digestion of GP before dephenolisation.

From the research work on OMW, a study about total polyphenols determination by colorimetric method was carried out. Indeed, solid phase extraction break-through curves obtained during polyphenols recovery experiment were employed as a tool for the analysis.

To increase the volatile fatty acids (VFAs) concentration, for obtaining a feeding solution which allow fed-batch fermentation, it was proposed to concentrate VFAs produced in acidogenic digestion using nanofiltration (NF). A preliminary feasibility study has been carried out, getting rejections in the range 30-90%, using a plant-counter and prepared in the laboratory of VFAS solution (C2 to C6) salts and buffers in distilled water.

The optimization of the PHAs downstream process was also studied. It is been developed a procedure for the extraction of PHAs by cell pretreatment with, heat, acids, digestion with NaOH and ethanol-water washing. In this study it was verified that the implementation of a pre-treatment with H₂SO₄ allows to recover 85% of PHAs products reaching a purity of >95%.

KEYWORDS: Biopolymer, Polyhydroxyalkanoates, Volatile fatty acids, Agro-industrial wastes, Residues, Valorisation, Biorefinery

TABLE OF CONTENTS

1	MOTIVATION AND THESIS OUTLINE.....	1
1.1	MOTIVATION	2
1.2	THESIS OUTLINE	3
2	POLYHYDROXYALKANOATES PRODUCTION FROM OLIVE MILL WASTEWATER.....	4
2.1	INTRODUCTION	5
2.2	MATERIAL AND METHODS	7
2.2.1	CHEMICALS AND OLIVE MILL WASTEWATER	7
2.2.2	BACTERIAL STRAIN, INOCULUM AND CULTURE MEDIA FOR PHAs PRODUCTION	8
2.2.2.1	GROWTH AND PHAs PRODUCTION EXPERIMENTS USING THE OMW 2012	8
2.2.2.2	PHAs PRODUCTION (USING THE OMW 2013) IN THE FRAME OF AN INTEGRATED BIOREFINERY SCHEME	9
2.2.3	EXPERIMENTAL APPROACH.....	10
2.2.3.1	GROWTH WITHIN A MEDIA CONTAINING OMW _{Deph} 60% DEPHENOLISED	10
2.2.3.2	ACCUMULATION STUDIES USING OMW _{Acid} (60% DEPHENOLISED).....	11
2.2.3.2.1	PHAs ACCUMULATION WITHIN OMW _{Acid}	11
2.2.3.2.2	PHAs ACCUMULATION WITHIN Sim _{VFAs} OMW _{Acid}	11
2.2.3.2.3	PHAs ACCUMULATION WITHIN Sim _{Phen} OMW _{Acid}	11
2.2.3.2.4	PHAs ACCUMULATION BY APPLYING MULTIPLE BATCHES	11
2.2.3.3	AN INTEGRATED OMW BIOREFINERY FOR PRODUCING A POLYPHENOLS MIXTURE, PHAs AND BIOGAS: A <i>TECHNICAL FEASIBILITY STUDY</i>	12
2.2.3.3.1	CONTINUOUS POLYPHENOLS RECOVERY.....	12
2.2.3.3.2	ANAEROBIC ACIDOGENIC DIGESTION OF <i>OMW_{Deph}, cont</i>	13
2.2.3.3.3	PHAs PRODUCTION FROM <i>OMW_{Deph}, contAcid</i>	13
2.2.3.3.4	ANAEROBIC METHANOGENIC DIGESTION OF <i>OMW_{Solid}</i>	14
2.3	ANALYTICAL PROCEDURES	14
2.4	RESULTS AND DISCUSION.....	15
2.4.1	GROWTH WITHIN A MEDIA CONTAINING OMW _{Deph} (60% DEPHENOLISED).....	16
2.4.2	ACCUMULATION STUDIES USING OMW _{Acid} (60 % dephenolised).....	16
2.4.2.1	PHAs ACCUMULATION WITHIN OMW _{Acid}	17
2.4.2.2	PHAs ACCUMULATION WITHIN Sim _{VFAs} OMW _{Acid}	20
2.4.2.3	PHAs ACCUMULATION WITHIN Sim _{Phen} OMW _{Acid}	22
2.4.2.4	PHAs ACCUMULATION BY APPLYING MULTIPLE BATCHES	24
2.4.3	INTEGRATED BIOREFINERY OF OMW FOR PRODUCING A POLYPHENOLS MIXTURE, BIOPOLYMER AND BIOGAS: <i>TECHNICAL FEASIBILITY STUDY</i>	28

2.4.3.1	CONTINUOUS POLYPHENOLS RECOVERY	28
2.4.3.2	ANAEROBIC ACIDOGENIC DIGESTION OF <i>OMWDeph, cont</i>	29
2.4.3.3	PHAs PRODUCTION FROM <i>OMWDeph, contAcid</i>	30
2.4.3.4	ANAEROBIC METHANOGENIC DIGESTION OF <i>OMWSolid</i>	32
2.5	CONCLUSIONS	35
3	POLYHYDROXYALKANOATES PRODUCTION FROM GRAPE POMACE	36
3.1	INTRODUCTION	37
3.2	MATERIAL AND METHODS	39
3.2.1	CHEMICALS AND GRAPE POMACES.....	39
3.2.2	POLYPHENOLS EXTRACTION.....	40
3.2.3	ANAEROBIC ACIDOGENIC DIGESTION OF GP _{Deph} or GP _{Fresh}	41
3.2.4	PHAs PRODUCTION	41
3.2.4.1	Bacteria strains, inoculums and culture media	41
3.2.4.1.1	PHAs from <i>GPDephAcid</i>	41
3.2.4.1.2	PHAs from <i>GPFreshAcid</i>	42
3.2.4.2	Experimental approach	43
3.2.4.2.1	PHAs from <i>GPDephAcid</i>	43
3.2.4.2.2	PHAs from <i>GPFreshAcid</i>	43
3.2.5	BIOGAS PRODUCTION	43
3.2.6	ANALYTICAL PROCEDURES	44
3.3	RESULTS AND DISCUSION.....	46
3.3.1	POLYPHENOLS EXTRACTION.....	46
3.3.2	VFAs PRODUCTION.....	48
3.3.2.1	VFAs FROM <i>GPDeph</i>	48
3.3.2.2	VFAs FROM <i>GPFresh</i>	49
3.3.3	PHAs PRODUCTION	50
3.3.3.1	PHAs FROM <i>GPDephAcid</i>	50
3.3.3.2	PHAs FROM <i>GPFreshAcid</i>	53
3.3.4	BIOGAS PRODUCTION	57
3.3.4.1	BIOGAS FROM <i>GPDeph; SolidAcid</i>	57
3.3.4.2	BIOGAS FROM <i>GPFresh; solidAcid</i>	58
3.4	CONCLUSIONS	59
4	VFAs RECOVERY AND CONCENTRATION FROM ACIDOGENIC EFFLUENTS	60
4.1	INTRODUCTION	61
4.2	MATERIAL AND METHODS	65
4.2.1	CHEMICALS AND STANDARDS.....	65

4.2.2	EXPERIMENTAL SET-UP	65
4.3	RESULTS AND DISCUSION.....	67
4.4	CONCLUSIONS	69
5	TOTAL PHENOLS DETERMINATION IN OLIVE MILL WASTEWATER BY COLORIMETRIC AND HPLC METHODS.....	70
5.1	INTRODUCTION	71
5.2	MATERIALS AND METHODS	73
5.2.1	OMWs, chemicals and standards.....	73
5.2.2	Dephenolisation in bench-top packed column operating in continuous.....	73
5.2.3	Total phenols determination with colorimetric procedures.....	73
5.2.4	Total phenols determination with HPLC	74
5.2.5	Chemical oxygen demand (COD).....	74
5.3	RESULTS AND DISCUSSION	74
5.3.1	Methods comparison	74
5.3.2	Colour development reaction for the down-scaled method: 25°C or 75°C.....	75
5.3.3	Matrix interference analysis.....	76
5.3.4	Phenolic compounds determination with the down-scaled colorimetric and the HPLC methods: correlation between methods.....	77
5.4	CONCLUSION	80
6	RECOVERY AND PURIFICATION OF POLYHYDROXYALKANOATES	82
6.1	INTRODUCTION	83
6.2	MATERIAL AND METHODS	83
6.2.1	CHEMICALS AND STANDARDS.....	83
6.2.2	PHAs PRODUCTION AT BENCH-TOP BIOREACTOR	83
6.2.3	PHAs RECOVERY AND PURIFICATION TESTS.....	84
6.2.4	ANALYTICAL PROCEDURES	84
6.3	RESULTS AND DISCUSSION.....	85
6.3.1	PHAs production in bioreactor.....	85
6.3.2	PHAs recovery and purification tests	85
6.3.2.1	Required digestion time	85
6.3.2.2	Influence of temperature and agitation.....	86
6.3.2.3	Biomass concentration optimization	86
6.3.2.4	NaOH concentration optimization	87
6.3.2.5	Ethanol washing: required time	87
6.3.2.6	Pre-treatment implementation.....	87
6.4	CONCLUSIONS	88

7	GENERAL CONCLUSION AND FUTURE WORK.....	89
7.1	GENERAL CONCLUSIONS	90
7.2	FUTURE WORK	91
8	APPENDICES	92
8.1	POLYHYDROXYALKANOATES QUANTIFICATION BY GAS-CHROMATOGRAPHY ANALYSIS: <i>PROCEDURE SET-UP</i>	93
8.1.1	Methanolysis treatment time	93
8.1.2	Methanolysis-GC Calibration.....	100
8.1.3	Methanolysis-GC Treated biomass linearity	104
9	REFERENCES	106

LIST OF FIGURES

Figure 1: (A) World and European plastic production trends [104]. (B) Estimated market demand for biobased plastics in the EU [105].	2
Figure 2: Production steps: 1 st growth phase using simple sugars and 2 nd the accumulation phase using VFAs under NH ₄ limitation.	10
Figure 3: Continuous OMW dephenolisation pilot-plant. OMW is treated in columns 1 and 2, that work alternately. When one column is absorbing polyphenols the other one is desorbing them within an acidified ethanol solution. The polyphenols are obtained at the same time the ethanol is recovered for recycling it.	13
Figure 4: Absorbance (Abs ₆₀₀) trends during the growth phase when OMW _{Acid} represented 0, 25, 50, 75 or 100 % v/v of the culture medium.	16
Figure 5: Time course profiles of main experimental parameters during the accumulation phase when OMW _{Acid} represented 25 (Δ), 50 (□), 75 (○) or 100 % (×) v/v of the accumulation medium: (A) Absorbance (Abs ₆₀₀) values related to growth (—◇—) and accumulation phases; (B) PHAs content (PHAs _{cont}) related to accumulating conditions (% , g/g); (C) Total VFA concentrations; (D) concentration of Acetic (—●—), propionic (---) and butyric acids (—) when OMW _{Acid} represented 25% of the flask working volume.	19
Figure 6: Time course profiles of main experimental parameters during the accumulation phase when Sim _{VFAs} OMW _{Acid} represented 25 (Δ), 50 (□), 75 (○) or 100% (×) v/v of the accumulation medium: (A) Absorbance (Abs ₆₀₀) values related to growth (—◇—) and accumulation phases; (B) Total VFA concentrations; (C) concentration of acetic (—●—), propionic (---) and butyric acids (—) when Sim _{VFAs} OMW _{Acid} represented 50% of the flask working volume.	21
Figure 7: Time course profiles of main experimental parameters during the accumulation phase when Sim _{Phen} OMW _{Acid} represented 10 % (Δ), 25 % (□), 40 % (○) and 55 % (×) v/v of the accumulation medium: (A) Absorbance (Abs ₆₀₀) values related to growth (—◇—) and accumulation phases; (B) Total VFA concentrations; (C) PHAs content (PHAs _{cont}) related to accumulating conditions (% , g g ⁻¹).	23
Figure 8: Time course profiles of main experimental parameters during the accumulation phase when OMW _{Acid} (□) and Sim _{VFAs} OMW _{Acid} (○) represented 50% v/v of the accumulation media; and when the same solutions represented 25% v/v of the accumulation media and two sequential accumulation batch processes were applied (Δ and ×, respectively): (A) Absorbance (Abs ₆₀₀) values related to growth (—◇—) and accumulation phases; (B) Total VFA concentrations; (C) PHAs content (PHAs _{cont}) related to accumulating conditions (% , g g ⁻¹).	26
Figure 9: Dephenolisation break-through test. Samples taken from the exit stream of the column to analyse: total phenols content (TPhs) and COD. The presented values are the mean of three measurements and standard deviation is represented by error bars.	28
Figure 10: VFAs concentration trends along acidogenic batch process.	30
Figure 11: Time course profiles of main experimental parameters during the accumulation phase when OMW _{Acid} and Sim _{VFAs} OMW _{Acid} represented 100 % v/v of the accumulation media. (A) Cell concentration in terms of absorbance (Abs ₆₀₀) and (B) carbon substrate concentration - glucose and total VFA concentrations-; both related to growth and accumulation phases.	31
Figure 12: Thermo-gravimetric analysis of samples taken at the end of the growth phase (curve in red) and samples belonging to the end of the last accumulation batch (blue for OMW _{Acid} and green for Sim _{VFAs} OMW _{Acid}).	32
Figure 13: Effective biogas production using OMW _{Solid} as substrate.	32

Figure 14: Biomethane production using OMW _{Solid} at different concentrations; from 0.064 (K1) to 99.5 (K7) g SV . L ⁻¹ and K0 was the blank.	33
Figure 15: BMP after 60 days as a function of initial substrate concentration	33
Figure 16: Specific rate of CH ₄ production (rCH ₄) as a function of substrate concentration. (A) Presented results are: experimental data obtained in the first (PE) and second experiment (K1-K7) and Michaelis-Menten and Aiba models fittings.	34
Figure 17: Multi-purpose biorefinery scheme for the obtainment of polyphenols and biopolymer from red grape pomace (GP).	39
Figure 18: Schematic pilot-scale extractor: (B1) Storage tank, (E1) extraction vessel, (S1, S2) separators, (H#) heat exchangers; (C1) condenser; (HV#) Hand valves; (MV1) membrane valve; (NVR#) no return valves; (P) diaphragm pumps; (F1) flowmeter; (M#) manometers; (k) safety devices; (FL1) coriolis mass flowmeter; (D) co-solvent storage tank; (X#) mixer.	40
Figure 19: VFAs production from <i>GPDeph</i> . Single and total VFA concentration trends.....	48
Figure 20: Responses of grown cells to 20% and 40% of <i>GPDephAcid</i> and <i>SimGPDephAcid</i> contents in the accumulation media (% v/v). (A) Absorbance (Abs600) values as a function of the time related to growth (--●--) and accumulation phase. (B) Total VFAs consumption profiles. (C) PHAs content (% on a cell dry weight basis) obtained from GC analyses.....	51
Figure 21: mcl-PHAs production in two stages (A, B) and in one stage (C, D) using <i>GPFreshAcid</i> (red curves) or <i>Sim_GPFreshAcid</i> (red curves). Cell concentration is reported in terms of absorbances (Abs), cell dry weight (CDW) and residual cell material (RCM, non-PHAs material).....	54
Figure 25: mcl-PHAs production in two stages (A, B) and in one stage (C, D) using <i>GPFreshAcid</i> (red curves) or <i>Sim_GPFreshAcid</i> (red curves). Cell concentration is reported in terms of absorbances (Abs), cell dry weight (CDW) and residual cell material (RCM, non-PHAs material).....	55
Figure 26: ¹ H-NMR and ¹³ C-NMR analyses.....	56
Figure 24: Effective biogas production using <i>GPDephAcid</i> solid fraction. Accumulated hydrogen, methane and carbon dioxide production trends.	57
Figure 25: Biomethane production from <i>GPFresh; SolidAcid</i>	58
Figure 26: Comparison of biomethane production (right) and biogas compositions (left) for the different AD substrates.	59
Figure 27: The production of volatile fatty acids (C ₂ -C ₆) from agro-industrial wastes such as: olive mill wastewater (OMW), grape pomace (GP), cheese whey (CW), organic fraction of municipal waste (OFMW) or fruit &.vegetable waste (FVW). Main utilization of the VFAs potentially produced.....	61
Figure 28: NF bench-top plant.	65
Figure 29: An hypothesised scheme for VFAs separation-concentration, also considering the single separation.	66
Figure 30: Results obtained at different operating pressures (5-30 bar) at fixed pH and temperature.	67
Figure 31: Water permeate test	68
Figure 32: VFAs separation using DK or AK. Rejected values against pH condition.	68
Figure 33: Correlation curve for absorbances obtained -with the down-scaled procedure- by performing the color development at 75°C and at 25°C. Each point represent the average value of three analyses and standard deviation is represented by the error bars.	76

Figure 34: Calibration curves using OMW _{Deph} as solvent for preparing the standards and dionex water (◊) or OMW _{Deph} (*) when making the reaction for preparing the blank.....	77
Figure 35: Dephenolisation break-through test. TPhs content in the samples taken from the exit stream of the column and analyzed by colorimetric and HPLC methods (real values were multiplied by 2). Also COD was analyzed. The presented values are the mean of three measurements and standard deviation is represented by error bars. For the HPLC, single analyses values are presented and the standard deviation was calculated from the calibration.	78
Figure 36: Correlation analysis. TPhs determined by HPLC-UV vs TPhs determined by the colorimetric method.	78
Figure 37: Correlation analysis between TPhs determined by HPLC-UV and COD.....	79
Figure 38: Correlation analysis between COD and TPhs determined by colorimetric method..	80
Figure 39: PHAs production. Concentration trends during the fed-batch fermentation.	85
Figure 40: Required digestion time of non-PHAs biomass digestion with NaOH 0.1N at 30°C, measured as PHAs purity in the remaining pellet.....	86
Figure 41: Post-treatment: washing with ethanol 20% v/v	87
Figure 42: Pre-treatment with acids 0.1N at 80°C for 2 hours, followed by digestion with NaOH and washing even with ethanol.	88

LIST OF TABLES

Table 1: OMW _{Acid} main features.	8
Table 2: Main performances of accumulation processes fed with 25 or 50% v/v of OMW _{Acid} , which led to PHAs accumulation: PHAs content (PHAs _{Cont}) and yield (Y _{PHAs/VFAs}); specific HV content in the produced co-polymer (HV%); specific accumulation rate (Π _{Accum}); acetic, propionic and butyric acids consumption averages rates (ΔAc / Δt, ΔPro / Δt and ΔBut / Δt, respectively); total VFAs consumptions (ΔVFAs _{Tot}); final pH values.	19
Table 3: Main performances of accumulation processes fed with 25, 50, 75 or 50% v/v of Sim _{VFAs} OMW _{Acid} : PHAs content (PHAs _{Cont}) and yield (Y _{PHAs/VFAs}); specific HV content in the produced co-polymer (HV%); specific accumulation rate (Π _{Accum}); acetic, propionic and butyric acids consumption averages rates (ΔAc / Δt, ΔPro / Δt and ΔBut / Δt, respectively); total VFAs consumptions (ΔVFAs _{Tot}); final pH values.	21
Table 4: Main performances of accumulation processes fed with Sim _{Phen} OMW _{Acid} containing 10, 25, 40 or 55 % of total polyphenols occurring in OMW _{Acid} : PHAs content (PHAs _{Cont}) and yield (Y _{PHAs/VFAs}); specific accumulation rate (Π _{Accum}); acetic, propionic and butyric acids consumption averages rates (ΔAc / Δt, ΔPro / Δt and ΔBut / Δt, respectively); total VFA consumptions (ΔVFAs _{Tot}); initial (i) and final (f) cell concentrations (X); final pH values.	24
Table 5: Main performances of accumulation processes fed with 25 % of OMW _{acid} and Sim _{VFA} OMW _{Acid} when two consecutive batch processes were applied: PHAs content (PHAs _{Cont}) and yield (Y _{PHAs/VFAs}); specific accumulation rate (Π _{Accum}); acetic, propionic and butyric acids consumption averages rates (ΔAc / Δt, ΔPro / Δt and ΔBut / Δt, respectively); total VFA consumptions (ΔVFAs _{Tot}); initial (i) and final (f) cell concentrations (X); final pH values.....	25
Table 6: OMW 2013 original and post-dephenolisation characteristics.	29
Table 7: Chemical composition of GP extracts obtained by methanol and SC-CO ₂ + 10% EtW extraction methods.....	47
Table 8: VFAs mixtures compositions obtained using GPDephAcid and GPACid.....	50
Table 9: PHAs content (PHAs _{Cont}); PHAs yield (Y _{PHAs/VFAs}); specific accumulation rate (Π _{Accum}); final pH values; obtained when using <i>GPDephAcid</i> and <i>SimGPDephAcid</i> at different contents during the accumulation phase.....	52
Table 10: Polymer characterization by gel permeation chromatography and differential scanning calorimetry.....	57
Table 11: Typical acidogenic effluent composition.....	63
Table 12: Literature review (till 2014) about VFAs separation using NF.	64
Table 13: OMW average physicochemical characterization (Alberto Scoma, 2014).....	71
Table 14: Comparison of TPhs values, standard deviation (STD) and percent standard deviation (%STD) obtained with three methods: COLORIM 1 (performed at 25mL and 75°C (REF)), COLORIM 2 (performed at 1.3mL and 25°C) and HPLC_UV.....	75
Table 15: NaOH digestion, influence of temperature and stirring	86
Table 16: NaOH digestion, maximum biomass concentration	86
Table 17:	87

1 MOTIVATION AND THESIS OUTLINE

1.1 MOTIVATION

“Polymers are the newcomers among the bulk materials used in modern economies” [1]. Statistics arise that world plastics production, including thermoplastics and elastomers among others, has a growth trend since 1950 (**Figure 1 A**). Nowadays, this is also true for biobased polymers (**Figure 1 B**); produced from renewable resources allow independency from petrol and avoid land filling. In this line, polylactic (PLA) acid and polyhydroxyalkanoates (PHAs) were previously considered as potential substitutes of petrol-based polymers. Differing from PLA, PHAs allow the obtainment of a variety (a family) of polymers with different characteristics. Nevertheless, nowadays it is hardly economically feasible its industrial production mainly due to carbon source and downstream costs; both accounting 40-60% of the final product cost [2].

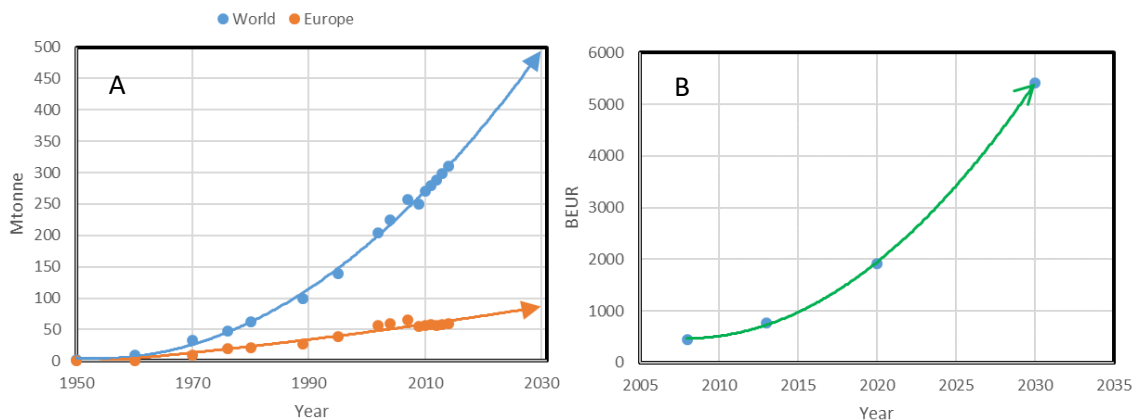

Figure 1: (A) World and European plastic production trends [104]. (B) Estimated market demand for biobased plastics in the EU [105].

From all that mention, the main goal of the present thesis was to develop polyhydroxyalkanoates (PHAs) production processes using agro-industrial wastes as alternative carbon sources and pure cultures. This production study was carried out in the frame of biorefineries development, as to maximise waste valorisation. Therefore, the specific aims were to:

- 1- Study the valorisation of Italian agro-industrial wastes through the production of PHAs
 - a. The production of PHAs using acidified effluents
 - b. Development of a biorefinery scheme that allow integrated valorisation, including at least polyphenols recovery and biogas production from wastes streams
- 2- Study the implementation of a water-based PHAs down-stream process

1.2 THESIS OUTLINE

The thesis includes 9 chapters describing the work carried out during the three years of PhD.

The present chapter (Chapter 1) contains the motivation and objectives of the project.

Following to this, PHAs production studies are presented: using olive mill wastewater (Chapter 2) and grape pomaces (Chapter 3); where integrated schemes development have been studied.

For the second residue, also an alternative valorisation scheme was developed.

During the research on PHAs production using alternative carbon sources, organic acids concentration was identified as a potential key process for the pretended biorefinery schemes.

Thus, the implementation of nanofiltration-concentration step was preliminary studied (Chapter 4).

While studying the valorisation of olive mill wastewater, this when testing PHAs production or designing a biorefinery scheme, it was identified the total phenols measurement as an important analytical tool. Hence, a study was dedicated (Chapter 5) in order to understand the accuracy of an already established (however down-scaled) colorimetric method.

The PHAs down-stream process was studied on Chapter 6. Specifically, trying to optimize a water based recovery and purification procedure.

Each of these chapters are constituted by introduction within a brief state of art, description of material and methods employed for carrying out the work, results and discussion and conclusions.

Finally, main conclusions of the PhD project and future work suggestions are presented in Chapter 7.

Chapter 8 contains the appendices and Chapter 9 the references.

2 POLYHYDROXYALKANOATES PRODUCTION FROM OLIVE MILL WASTEWATER

Summary The feasibility of producing polyhydroxyalkanoates (PHAs) by feeding a pure culture of *Cupriavidus necator* with a pre-treated olive mill wastewater (OMW) was demonstrated at 500 mL shaken flask scale. The OMW was previously dephenolised and then fermented to produce an effluent rich in volatile fatty acids (VFAs). The latter stream (OMW_{Acid}) was then employed as the carbon source for PHAs production. Firstly, pre-grown cells were fed with different dilutions of OMW_{Acid}, namely: 25, 50, 75 and 100 % v/v. Significant inhibitory effects were observed when OMW_{Acid} concentration was 75 and 100 %. Thereafter, experiments with laboratory prepared solutions, simulating the OMW_{Acid}, allowed to demonstrate that polyphenols significantly contributed to the observed inhibition. Furthermore, The copolymer poly(3-hydroxybutyrate-co-3-hydroxyvalerate) (poly(HB-co-HV)), containing 11% of hydroxyvalerate, was accumulated up to 55% of the cells dry weight when two consecutive accumulation batch processes were carried out with 25% of OMW_{Acid} and without adding any exogenous carbon source. The obtained results are promising in the perspective of continuing the production study at a bench-top bioreactor scale and thereafter analysing the possibility of developing a biotechnological PHAs production process as a part of an integrated OMW valorisation process.

* Chapter adapted from *Gonzalo Agustín Martínez, Lorenzo Bertin, Alberto Scoma, Stefano Rebecchi, Gerhart Braunegg, Fabio Fava, Production of polyhydroxyalkanoates from dephenolised and fermented olive mill wastewater by employing a pure culture of Cupriavidus necator, Biochemical Engineering Journal, 97 (2015) 92–100 [3]*

2.1 INTRODUCTION

Polyhydroxyalkanoates (PHAs) are well known aliphatic polyesters naturally produced by many microorganisms [4,5]. Different materials with new properties can be obtained by combining different PHAs monomers, including bioplastics with similar or even better physicochemical and mechanical properties than those exerted by their petrochemical-based homologues polyolefins. As an example, a polymer with a lower oxygen permeability, which can be exploited to enhance the material features of food packaging, can be obtained [6–9]. Besides, PHAs can be produced from renewable resources, therefore representing one of the most promising biopolymers for replacing the petrochemical-based plastomers, elastomers, latexes or even high-performance polymers [10].

Nevertheless, nowadays, PHAs industrial production is carried out from expensive carbon sources, resulting in a hardly economically competitive product with respect to that of petrol-based polymers. The production costs are mainly associated to those of carbon source procurement and down-stream process (recovery and purification), representing both 30-50 % (approximately) of the final product cost [2]. Thus, new alternatives and strategies are being studied in order to lower PHAs production costs. To this aim, the application of alternative inexpensive carbon sources, usually represented by agro-industrial wastes [11], was widely studied. Fried oil [12], effluents from the palm mill [13], molasses [14], cheese whey [15], olive mill wastewater (OMW) [16] and biodiesel waste glycerol [15,17], among others, were tested with pure or mixed cultures. Pure cultures (wild type or genetically modified) allow getting higher productivities and PHAs content. Conversely, the employment of mixed cultures has the economic advantage that they do not need to work under sterile conditions, since the microbial selection of PHAs producer strains can be carried out under selective pressure by repeated feast and famine processes [18].

On the other hand, most of the mentioned alternative substrates have moderate to low carbon source concentration (around 80 g/L and 10–40 g/L, respectively), this leading to a low PHAs productivity potential [19], which hence negatively affects process costs. Pure cells allow high cell densities and PHAs contents, which conversely contribute moderating downstream costs. Furthermore, the employment of a single bacterial strain allows the obtainment of a well-defined single type of polymer, while a mixture of polymers would be obtained from microbial consortia.

The present work was dedicated to evaluate the possibility of producing PHAs by employing a pure culture and an inexpensive substrate. In particular, *Cupriavidus necator* (formerly *Ralstonia*

2. POLYHYDROXYALKANOATES PRODUCTION FROM OLIVE MILL WASTEWATER

eutropha) was chosen as the biocatalyst since it is a well-known and robust PHAs producer strain capable of high accumulation potential. OMW was selected as the alternative carbon source because it is an abundant biowaste mostly produced within the Mediterranean region. Particularly, the experimental wastewater was produced in Italy, where about 1 Mm³ of OMWs are generated per year (FAO and [20]). OMW is a typical effluent of the olive oil industry, which applies the conventional three phases extraction procedure. Compared to the biowaste obtained from the two phase extraction one (mainly generated in Spain and conventionally called “alperujo”), which includes the solid fraction from processed olives, OMW is a much more homogeneous and liquid effluent. It is considered an environmental harmful waste because of its typical acidity (pH 3 - 6), high organic content (40 - 200 g COD / L), occurrence of polyphenolic compounds (1 - 20 g/L), and seasonality [21]. Polyphenols are known to exert antimicrobial activity; on the other hand, they are natural antioxidants, which could be exploited in several industrial fields [22]. All this considered, the development of integrated OMW valorisation processes would allow combining its treatment to the obtainment of added value products (e.g., polyphenols, PHAs and biogas).

In this work, in a first study, the experimental OMW was previously dephenolised (*in batch*) in order to couple the recovery of added value molecules to a detoxification of the effluent. Then, it was digested under acidogenic condition to obtain a volatile fatty acids (VFAs)-rich stream (OMW_{Acid}), which was used as the carbon source for PHAs accumulation. More in details, the main aims of the present study were: (a) to verify the possibility of producing PHAs, by using a pre-grown culture of *C. necator*, from OMW_{Acid}; (b) to determine what type of polymer can be produced from OMW_{Acid}; (c) to study the occurrence of inhibitory effects due to OMW_{Acid} concentration and determine the potential inhibitors by employing laboratory pre-prepared OMW simulating solutions; and (d) to verify the possibility of increasing PHAs content by applying consecutive accumulation batch processes, with the perspective of developing a cell-recycling strategy for achieving a high cell density. All experiments were carried out in 500 mL shake flasks. To the very best of our knowledge, this work represents the first attempt to produce PHAs within a pure culture of *C. necator* by employing digested OMW as alternative carbon source.

A second study was carried out to verify the technical feasibility of valorising the OMW through an integrated biorefinery scheme. In particular, the sequential steps consisted on: continuous dephenolisation (better than batch), anaerobic acidogenic digestion, PHAs production and methanogenic digestion of the suspended solids occurring in the OMW. Finally, using the last obtained results, a preliminary techno-economic analysis was carried out within a bioprocess simulating tool.

2.2 MATERIAL AND METHODS

2.2.1 CHEMICALS AND OLIVE MILL WASTEWATER

The standard volatile fatty acids (VFAs) mixture (Supelco), poly(3-hydroxybutyric acid-co-3-hydroxyvaleric acid) (Poly(HB-co-HV)) (12 mol % PHV; natural origin), salts (BioReagent) for the mineral medium, single VFAs and fructose (BioReagent) were purchased from Sigma–Aldrich. The OMWs, from 2012 (used in Sections 2.2.3.1 and 2.2.3.2) and from 2013 (used in Section 2.2.3.3), were kindly supplied by the “Sant’Agata d’Oneglia” Italian olive mill, which is located in the Liguria northern region, and it had a COD of about 55 g/L (2012) and 26 g/L (2013), partially due to polyphenolic compounds (about 2.55 g/L and 1 g/L, respectively).

The OMW 2012 (used in sections 2.2.3.1 and 2.2.3.2) underwent a pretreatment procedure, which consisted in a solid phase extraction (SPE), which was carried out by using a non-polar resin (Amberlite XAD16, Sigma–Aldrich) as the adsorbent and ethanol (96% grade, Sigma–Aldrich) as the desorption solvent [22]. The SPE batch procedure enabled the removal of the polyphenolic fraction; however, a significant amount of total polyphenols still occurred (

2. POLYHYDROXYALKANOATES PRODUCTION FROM OLIVE MILL WASTEWATER

Table 1. Thereafter, the dephenolised wastewater (OMW_{Deph}) was processed under anaerobic acidogenic conditions in order to obtain an effluent rich in VFAs (OMW_{Acid}), which was employed as the carbon source for the biological accumulation of PHAs. The anaerobic acidogenic digestion of the OMW was carried out in a 2.5 L packed bed bioreactor, whose configuration was reported elsewhere [23]. In brief, it was an up-flow glass column, which was packed with ceramic material and was operating under continuous mode at 35°C with a hydraulic retention time (HRT) of 7 days. The main features of the OMW_{Acid} are shown in

2. POLYHYDROXYALKANOATES PRODUCTION FROM OLIVE MILL WASTEWATER

Table 1; it contained different short chain VFAs, mainly (g/L): acetic (7.22 ± 0.16), propionic (1.25 ± 0.05), butyric (1.75 ± 0.03), valeric (0.22 ± 0.04) and caproic (0.35 ± 0.01) acids.

The treatment for the OMW 2013 and its characteristics are described in Section 2.2.3.3.1.

Table 1: OMW_{Acid} main features.

COD (g COD / L)	31.4 ± 0.5
Total VFAs (g / L)	11.43 ± 0.6
Total phenols (g /L)^a	1.20 ± 0.20
pH	6.5 ± 0.1
N-NH₄ (mg / L)	60 ± 1
Proteins (g / L)	1.56 ± 0.12
Lipids (g / L)	3.24 ± 0.34

^a Expressed as gallic acid equivalents

2.2.2 BACTERIAL STRAIN, INOCULUM AND CULTURE MEDIA FOR PHAs PRODUCTION

C. necator DSMZ 545 (DSMZ, Germany) was used as the PHAs producer strain. Pre-cultures were started from agar plates and pre-grown within 24 h in 500 mL Erlenmeyer flask containing 150 mL of Luria Bertani (LB) medium without any extra carbon source [24]; incubation conditions were 30 °C and 150 rpm.

All experiments were performed according to a dual-phase strategy (as reported in Section 0).

2.2.2.1 GROWTH AND PHAs PRODUCTION EXPERIMENTS USING THE OMW 2012

For experiment of section 2.2.3.1, the mineral medium E2 [25] was prepared using the OMW_{Deph} as solvent (from the beginning) and fructose (5g/L) as carbon source. Regarding the experiments of Section 2.2.3.2, the same medium was always employed in the first process step dedicated to cell growth (balanced growth phase), while different culture media were utilised in the second process steps dedicated to PHAs production (accumulation phase), depending on specific experimental aims. All these accumulation media exerted a NH₄ limitation, which did not allow cell growth (essential nutrient limitation). At the same time, this limitation triggered the biopolymer accumulation. In particular, the growth medium consisted of a slightly modified E2 mineral medium and it was employed for the cell growth phase. It contained 1.5 instead of 1.1 g/L of NH₄HPO₄. Fructose (5 g/L) was added as the sole carbon source. Two types of ammonia free-media were employed for the subsequent PHAs accumulation phase: they included (a) the actual OMW_{Acid}, or (b) laboratory prepared solutions, which simulated OMW_{Acid} by containing target chemicals occurring in the actual acidogenic effluent (SimOMW_{Acid}). The former media were prepared by filtering the OMW_{Acid} with Whatman N11 (11 µm) filters, adding E2 salts (except for NH₄HPO₄) by respecting their concentration in the E2 medium, and autoclaving the amended OMW_{Acid} using special Beckman flasks, which allowed to perform a subsequent centrifugation (8000 RPM, 4°C and 25 min) under sterile conditions; finally, when necessary, it was diluted with a sterilised distilled water solution containing the same kind and concentration of E2 salts, so that such media contained 25, 50, 75 or 100% v/v of the amended OMW_{Acid}. Two kinds of SimOMW_{Acid} were

2. POLYHYDROXYALKANOATES PRODUCTION FROM OLIVE MILL WASTEWATER

employed, containing VFAs ($\text{Sim}_{\text{VFAs}}\text{OMW}_{\text{Acid}}$) or a mixture of VFAs and polyphenols ($\text{Sim}_{\text{Phen}}\text{OMW}_{\text{Acid}}$), respectively. In agreement with the preparation of accumulation media containing OMW_{Acid} , $\text{Sim}_{\text{VFAs}}\text{OMW}_{\text{Acid}}$ was prepared by combining different relative amounts of two sterilised stock solutions, namely: (a) a VFAs solution, where VFAs concentrations were the same of those occurring in the actual OMW_{Acid} (as reported in Section 2.2.1); and (b) sterile distilled water. $\text{Sim}_{\text{VFAs}}\text{OMW}_{\text{Acid}}$ media contained 25, 50, 75 or 100% v/v of the VFA solution. Both solutions were previously amended by adding E2 salts (except for NH_4HPO_4), by respecting their concentration in the E2 medium. Finally, $\text{Sim}_{\text{Phen}}\text{OMW}_{\text{Acid}}$ media were prepared by combining 30% v/v of the VFA solution described above with a sterilised polyphenolic aqueous solution. The latter solution was prepared as follows: the alcoholic polyphenolic solution obtained as a result of the dephenolisation process was dried under vacuum, using a rotary evaporator (25°C and 10 mbar). Then, resulting powder was resuspended in distilled water and, once completely dissolved, E2 salts (except for NH_4HPO_4) were amended and the solution was sterilised by filtration (Cellulose-acetate membrane, 0.2 μm and 25 mm). Total polyphenols concentration in the polyphenolic stock was 4 g/L. Such a solution was combined with the VFA solution and sterile distilled water, so that the total polyphenols concentration in $\text{Sim}_{\text{Phen}}\text{OMW}_{\text{Acid}}$ media were 10, 25, 40 or 55% of the total polyphenols concentration occurring in the actual OMW_{Acid} (

2. POLYHYDROXYALKANOATES PRODUCTION FROM OLIVE MILL WASTEWATER

Table 1), i.e., 0.12, 0.30, 0.48 and 0.66 g/L, respectively. All accumulation phases started with a pH of 7.2.

2.2.2.2 PHAs PRODUCTION (USING THE OMW 2013) IN THE FRAME OF AN INTEGRATED BIOREFINERY SCHEME

The mineral medium 81 (DSMZ) was employed with slightly differences: for the growth phase it contained 3 instead of 1 g L⁻¹ of (NH₄)₂SO₄ and, for triggering the accumulation phase, NH₄ free. Regarding the carbon source, glucose (5 g L⁻¹) was used for the 1st phase; while for the 2nd phase the medium was prepared by dissolving the medium salts in the liquid fraction of the acidified effluent, no distil water was used in this case.

2.2.3 EXPERIMENTAL APPROACH

First of all, a study was dedicated to verify the possibility of using pretreated OMW for cell growth and PHAs accumulation. Thereafter, a second study was carried out in order to verify the technical feasibility of valorising the OMW within an integrated biorefinery scheme that includes -among other steps- the PHAs production using a better dephenolised effluent.

The biopolymer production approach was the same in both studies. Being *C. necator* a non-growth associated producer, the whole PHAs production process was separated in a two-stages (Figure 2). They were dedicated to favour the bacterial growth and to induce the biopolymer

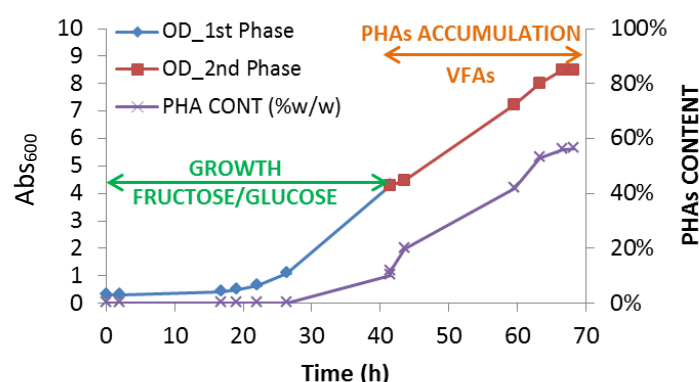

Figure 2: Production steps: 1st growth phase using simple sugars and 2nd the accumulation phase using VFAs under NH_4 limitation.

accumulation, respectively. The consecutive process steps were fed with a monosaccharide (growth phase) and the target biowaste (accumulation phase), respectively. Beside, PHAs may represent over 80 % of the whole CDW of *C. necator* strain [4,26]. This would allow potentially replacing about 80 % of the costly sugar required by the conventional PHAs production process. All PHAs production experiments were carried out using 500 mL Erlenmeyer flasks containing 150 mL of culture media, experimental conditions were tested in triplicate. Thus, presented results are the average of the triplicates and standard deviation if represented by error bars or \pm .

2.2.3.1 GROWTH WITHIN A MEDIA CONTAINING OMW_{Deph} 60% DEPHENOLISED

This experiment was dedicated to verify if OMW_{Deph} can be used for preparing the culture media (fresh water replacement). To this aim, a balanced growth test was carried out in a mineral salt medium and fructose, prepared by using different relative proportions of OMW_{Deph} (0, 25, 50, 75 and 100 % v/v) and distilled water.

2. POLYHYDROXYALKANOATES PRODUCTION FROM OLIVE MILL WASTEWATER

2.2.3.2 ACCUMULATION STUDIES USING OMW_{Acid} (60% DEPHENOLISED)

This study was focused on the PHAs accumulation phase. The growth phase was carried out under balanced growth conditions, using fructose as the carbon source. To this aim, pre-grown cells were harvested by centrifugation (6000 rpm for 5 min at 4°C) and suspended in the media to an initial absorbance (Abs_{600}) of about 0.4. The incubation conditions were the same mentioned in the former Section 2.2.2. After 24 h, cells were harvested by centrifugation (6000 rpm for 5 min at 4°C). Thereafter, the grown biomass was resuspended in the specific experimental accumulation medium (ammonia free) and the subsequent PHAs accumulation phase was started (second process phase). Four experimental sets were carried out, each experimental condition was tested in triplicate.

2.2.3.2.1 PHAs ACCUMULATION WITHIN OMW_{Acid}

A first trial was dedicated to verify the possibility of using OMW_{Acid} as an alternative carbon source for PHAs production by using *C. necator* as the biocatalyst and to determine which kind of polymer could be obtained. The employment of different OMW_{Acid} dilutions (up to 100% of the accumulation phase media, as reported in the former Section 2.2.2), allowed to study if the concentration of the OMW_{Acid} matter could affect the PHAs accumulation activity of grown cells.

2.2.3.2.2 PHAs ACCUMULATION WITHIN $Sim_{VFAs}OMW_{Acid}$

A second identical experiment was launched, by replacing OMW_{Acid} with the $Sim_{VFAs}OMW_{Acid}$, so that VFAs concentrations were the same of those tested with the different OMW_{Acid} solutions. This allowed determining if inhibitory effects on PHAs accumulation were due to VFAs content, by excluding the role of other chemicals occurring in OMW_{Acid} .

2.2.3.2.3 PHAs ACCUMULATION WITHIN $Sim_{Phen}OMW_{Acid}$

Furthermore, the inhibition of PHAs production due to polyphenols naturally occurring in the OMW_{Acid} was studied by means of a third experiment, which was carried out with accumulation culture media containing 30% v/v of $Sim_{VFAs}OMW_{Acid}$ together with different amounts of total phenols, as indicated above (Section 2.2.2).

2.2.3.2.4 PHAs ACCUMULATION BY APPLYING MULTIPLE BATCHES

Finally, the possibility of increasing the polymer content in cells fed with OMW_{Acid} and $Sim_{VFAs}OMW_{Acid}$ at 25% v/v was tested by applying a second consecutive accumulation batch process. To this aim, once the accumulation processes was concluded, cells were harvested and resuspended in fresh accumulation media. A consecutive batch processes was then carried out.

2. POLYHYDROXYALKANOATES PRODUCTION FROM OLIVE MILL WASTEWATER

2.2.3.3 AN INTEGRATED OMW BIOREFINERY FOR PRODUCING A POLYPHENOLS MIXTURE, PHAs AND BIOGAS: A *TECHNICAL FEASIBILITY STUDY*

As mentioned, once the conditions and limitations of using OMW for producing PHAs were known, a second study was dedicated to verify the feasibility of valorising the Italian OMW through sequential steps, namely: continuous SPE, acidogenic digestion, PHAs production (within a better dephenolised OMW) and methanogenic digestion. The proposed steps are described in the same order they occur. All steps were planned, designed and carried out by our research group, except the continuous dephenolisation step which was studied and optimized by Prof. Pinelli's group and thus it will be briefly presented in order to allow the analysis of the biorefinery scheme.

2.2.3.3.1 CONTINUOUS POLYPHENOLS RECOVERY

In the projected biorefinery the OMW 2013 (**Table 6**) was first centrifuged (8000 rpm, 6°C, 25 min) for separating the suspended solids (OMW_{Solid}) and thereafter the stocked liquid fraction was treated in a continuous SPE process [27]. Briefly, the OMW was filtered in-line (25 and 11 µm) and fed within a peristaltic pump to 4 columns in series (0.5 m length, 0.0244 m inner diameter, total resin bed 1.81m) at superficial velocity of 3.05 m · h⁻¹ (19 mL·min⁻¹). Each column was packed with XAD-16 (10mm quartz sand, 1810mm resin and 10mm quartz sand). After reaching the ratio $\frac{[PF]_{OUT}}{[PF]_{IN}} = 0.41 \pm 0.01$, feeding was stopped and desorption started. This was by feeding 5 bed volumes of an acidified ethanol solution (0.5% v/v of HCl 0.1N).

For the process simulation analysis, it was proposed to implement two columns working alternately for obtaining a dephenolised OMW (OMW_{Deph}) and the polyphenols mixture (**Figure 3**). Hence, when one column reaches the pre-established saturation level (5 bed volumes), OMW feed was stop in column 1 and starts in column 2, meanwhile -at that time- it starts the polyphenols desorption in column 1 by feeding the ethanol solution. Finally, the desorpted polyphenols were separated from the ethanol by vacuum distillation; allowing to recycle the solvent.

2. POLYHYDROXYALKANOATES PRODUCTION FROM OLIVE MILL WASTEWATER

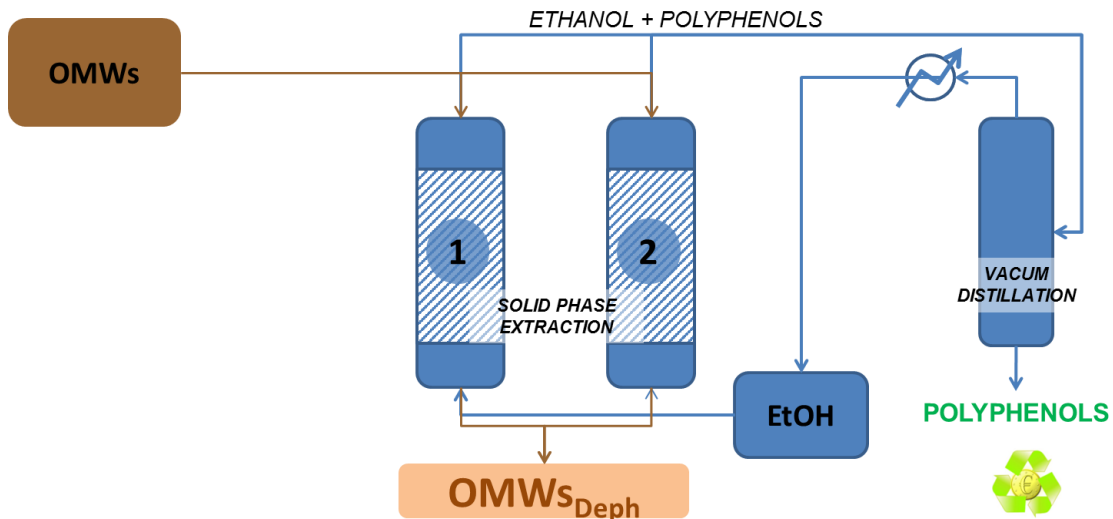

Figure 3: Continuous OMW dephenolisation pilot-plant. OMW is treated in columns 1 and 2, that work alternately. When one column is absorbing polyphenols the other one is desorbing them within an acidified ethanol solution. The polyphenols are obtained at the same time the ethanol is recovered for recycling it.

2.2.3.3.2 ANAEROBIC ACIDOGENIC DIGESTION OF $OMW_{Deph,cont}$

As in the first study (Section 2.2.1), the $OMW_{Deph,cont}$ still contains organic material. Thus, it was anaerobically digested under acidogenic conditions for obtaining a VFAs-rich stream ($OMW_{Deph,cont}^{Acid}$) with low total phenols concentration. To do this, it was employed the same packed bed bioreactor (and experimental set-up) described in Section 2.2.1, but in batch mode because of the lack of enough $OMW_{Deph,cont}$ quantity for starting a continuous process and arrive to a stationary state.

2.2.3.3.3 PHAs PRODUCTION FROM $OMW_{Deph,cont}^{Acid}$

In this case, since the OMW was better dephenolised (total phenols lower than 270 mg/L), it was proposed to use the $OMW_{Deph,cont}^{Acid}$ at 100 % v/v when preparing the culture media for the biopolymer production. As before, a parallel condition was run; in which the $OMW_{Deph,cont}^{Acid}$ was replaced with $Sim_{VFAs}OMW_{Deph,cont}^{Acid}$. This biopolymer production was carried out with the same approach as previously described: growth phase using simple sugars and accumulation phase using the VFAs occurring in the acidified stream. Multiple sequential batches were applied.

2. POLYHYDROXYALKANOATES PRODUCTION FROM OLIVE MILL WASTEWATER

2.2.3.3.4 ANAEROBIC METHANOGENIC DIGESTION OF OMW_{Solid}

The last step of the biorefinery consist of an overall digestion of all residues remaining in all streams. Hence, a preliminary test was carried out to verify the possibility of producing biogas from OMW_{Solid} and to evaluate the amount of biogas that can be produced. To this aim, 100-mL Pyrex bottles (microcosms with silicon septum, 55-mL working volume) were used. The OMW_{Solid} was resuspended and mix with the methanogenic inoculum. The final TS was 10 % and the inoculum to substrate rate was 0.44 (g of VS from the inoculum per gram of VS from the substrate) [28,29].

A next experiment was dedicated to study the OMW_{Solid} digestion kinetic. In this case, OMW_{Deph} was used as solvent instead of fresh-water. This was carried out also at microcosm scale, by testing different substrate concentrations, namely (C_{VS} in g/L; ISR): 0.064;1.000, 0.190;0.867, 0.580;0.813, 3.100;0.744, 5.980;0.707, 10.200;0.556 and 99.500;0.425.

In both experiments a control blank condition was run, prepared with inoculum and water. Thus, the results for each condition were analysed in terms of effective biogas produced; calculated by subtracting the biogas amount produced by the inoculum. All experimental conditions were carried out in triplicate.

2.3 ANALYTICAL PROCEDURES

Cell concentration measurements during PHAs production. In the growth phase was followed by turbidimetry, according to absorbance measurements at 600 nm (Abs600), by using a Cary-100 UV-vis spectrophotometer. Dilutions were performed when needed, so that absorbances (AU) values were always in the range 0-1. Two linear correlations were obtained when performing the Abs600 vs. cell dry weight (CDW) calibration curve: one for the growth phase and another for the accumulation phase (data not shown). Therefore, absorbance measurements were also used to detect PHAs production during the accumulation phase in agreement with [30–32]. PHAs were qualitatively and quantitatively determined by GC analyses, as described below. When accumulation media were high coloured solutions, due to the employment of OMW_{Acid} or polyphenols, the turbidimetrically analysed sample was centrifuged and supernatant absorbance was measured, in order to get a final absorbance measurement only related to suspended cells. The rest of the aqueous sample was centrifuged, and supernatant and pellet (after washing with NaCl 0.9%) were separated and stocked for analyses. For the accumulation phase samples, the pellet was dried and weighted for determining the biomass concentration (expressed in cell dry weight, g CDW / L) and PHAs content (g PHAs / g CDW × 100%).

2. POLYHYDROXYALKANOATES PRODUCTION FROM OLIVE MILL WASTEWATER

PHAs concentration and composition were determined PHAs were determined by GC-FID analysis (Agilent 7890 A), using a CP-Sil 5CB column (ID 0.25 mm, length 30 m and film thickness 0.25 μm) with the temperature program described in [33]. To this aim, the pellet samples were digested with methanol and chloroform according to the conventional method described in [34]; analytical procedure set-up is shown in **Appendice 8.1**. The employed standard was poly(HB-co-HV) (12 mol% PHV; natural origin).

Sugars and VFAs concentrations. Fructose or glucose concentration was determined by HPLC-IR analysis, using a Varian Hi-Plex H column (300 \times 7.7 mm); the mobile phase was sulphuric acid 5 mM at an elution rate of 0.6 ml/min and the operating temperature was 65°C. VFAs were determined by GC-FID analysis, using the Agilent 7890A and a HP-INNOWAX column (ID 0.25 mm, length 30 m and film thickness 0.25 μm) according to the method described in [23]. Organic matter consumption during the PHAs accumulation phase was followed by measuring the samples supernatant chemical oxy-gen demand (COD) with a commercial kit (AQUALYTIC Vario MR). A theoretical COD variation was calculated by only taking into account the VFAs consumptions. To this aim, VFAs concentrations were expressed as COD equivalents according to stoichiometric calculations and variation on these were calculated.

Total polyphenols contents (TPhs). First in the OMW_{Acid} and then in the extracted and concentrated solution (Section 2.3.3), TPhs were measured by the conventional Folin-Chocalteu colorimetric method [35], by using gallic acid as the analytical standard.

Biogas production. It was measured in terms of volume (glass syringe) and composition. This, in terms of H_2 , O_2 , CH_4 and CO_2 , was measured by gas-chromatography using a μGC (model 3000 A – Agilent Technologies, Milano, Italy) under the following conditions: injector temperature 90 °C; column temperature 60 °C; sampling time 20 s; injection time 50 ms; column pressure 25 psi; run time is 44 s and the carrier gas was nitrogen.

TS were determined by conventional gravimetric method exposing the sample to 105 °C overnight and VS were determined by exposing the resulting dried sample to 600 °C for 1 hour.

2.4 RESULTS AND DISCUSSION

The utilization of an alternative carbon source such as OMW, would potentially allow to diminish the PHAs production cost. Nevertheless, such potential production process would hardly results economically feasible as single. One of the reason, the lack of equipment occupancy optimization. On the other hand, an integrated valorisation with multiple products would allow

2. POLYHYDROXYALKANOATES PRODUCTION FROM OLIVE MILL WASTEWATER

to optimize this factor and others that will positively influence on the economically feasibility of the entire valorisation scheme.

Therefore, the work was divided in two: the first study was related specifically with the utilization of OMW for producing PHAs, and a second study was carried out in which the production of biopolymer was integrated with the obtainment of polyphenols, VFAs and biogas. Results are presented and discussed in the same order.

2.4.1 GROWTH WITHIN A MEDIA CONTAINING OMW_{Deph} (60% DEPHENOLISED)

Using OMW_{Deph} for preparing the media would potentially allow to substitute the utilization of fresh water. Hence, a growth experiment was carried out using different OMW_{Deph} contents (0-100 % v/v). The obtained results are presented in **Figure 4**. Long lag phases were detected in the conditions in which the OMW_{Deph} content was 50 % or higher. After 100 hours the 50 % condition grew to a similar extent of the lower concentrated conditions. From these results it was inferred that the OMW_{Deph} matrix contain one or more compounds that result growth inhibitors, such as phenols. Because of this, interest on using OMW_{Deph} (with this grade of dephenolisation) was lost, since it would increase the growth time to approximately double it.

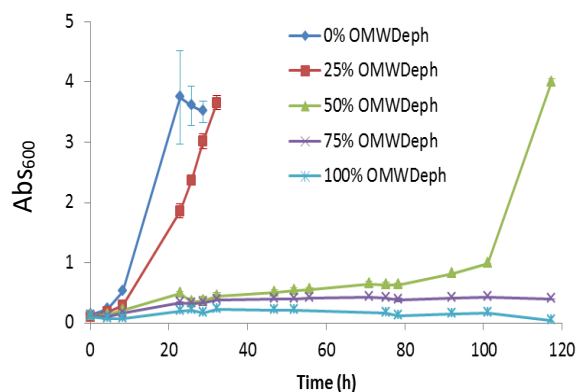

Figure 4: Absorbance (Abs₆₀₀) trends during the growth phase when OMW_{Acid} represented 0, 25, 50, 75 or 100 % v/v of the culture medium.

2.4.2 ACCUMULATION STUDIES USING OMW_{Acid} (60 % dephenolised)

Low cost carbon sources and high polymer contents are required in order to achieve an economically feasible biotechnological PHAs production process. In this section, a pure culture

2. POLYHYDROXYALKANOATES PRODUCTION FROM OLIVE MILL WASTEWATER

of *C. necator*, which is a PHAs producer with a rapid growth and a high accumulation potential (over 80 % of PHAs content on CDW bases [4,26]), was fed with a pretreated OMW in order to verify its capability of producing PHAs from such a biowaste. As a matter of fact, *C. necator* was found to grow and produce the biopolymer from diverse carbon sources [12,36–40]. *C. necator* is a non-growth associated PHAs producer. In fact, it accumulates the biopolymer by converting feasible PHAs precursors, such as VFAs, in the absence of other nutrients required for growth. Thus, the production process can be carried out according to a two sequential steps approach (dual-phase process), respectively dedicated to obtain a high cell concentration and to induce the grown biomass to produce and store PHAs [41]. The former process phase needs optimal cultivation conditions, including the employment of a simple sugar (such as glucose) as a readily bioavailable carbon source. VFAs do not represent a feasible carbon source for the bacterial growth, which is rather low especially when VFAs are odd-numbered, such as propionic and valeric acids are. Conversely, the latter PHAs accumulation phase, which requires nutrient limiting conditions, can be fed with different organic PHAs precursors. This evidence is of a high interest in the perspective of significantly lowering the employment of costly substrates by using an alternative carbon source for the accumulation phase. In fact, PHAs can represent the large majority of *C. necator* cell dry weight (CDW) and so the amount of sugar potentially substituted. The present section was focused on the utilization of a pre-treated biowaste (OMW_{Acid}) as the feeding for a PHAs production process mediated by a pure culture of a strain, data related to the cell growth phase (when fructose represented the carbon source) are briefly presented. In all experiments, the first batch process lasted from 23 to 26 h with a final cell concentration of 1.5 ± 0.2 g/L. Fructose consumption was 2.9 ± 0.3 g/L. Thereafter, cells were harvested and re-suspended in a specific accumulation medium. It is important to mention that grown cells already contained low PHAs amounts (up to 15 % w/w on CDW bases). This evidence is in agreement with previous observations [42] and did not prejudiced the proposed study, since significant PHAs productions from OMW_{Acid} were detected during the accumulation phase.

2.4.2.1 PHAs ACCUMULATION WITHIN OMW_{Acid}

A linear increase of Abs₆₀₀, ascribed to PHAs production and storage, was observed during the accumulation phase when OMW_{Acid} represented 25 % and 50 % of the flasks working volume (**Figure 5A**). Determinations of the PHAs content (calculated by GC analyses) confirmed that PHAs accumulation was responsible for that evidence (**Figure 5B**). The 25% condition started immediately, while an accumulation lag phase (about 24 h) was observed with 50% of OMW_{Acid}. The other tested conditions (75 % and 100 %) did not allow any PHAs accumulation: accordingly, absorbance, total VFAs concentrations and pH remained almost constant all along the

2. POLYHYDROXYALKANOATES PRODUCTION FROM OLIVE MILL WASTEWATER

accumulation phase (**Figure 5A, C**). Taken together, those evidences demonstrated an inhibitory effect due to the complex matrix of the employed substrate. Among others, two groups of chemicals could have exerted inhibitory effects, namely: polyphenols, which can modify the membrane fluidity [43,44], and VFAs, since they can interfere with the proton gradient mechanism [45].

Main results for both accumulating conditions are shown in **Table 2**. The 25 % condition was stopped after 22 h of accumulation (when CDW was 1.74 g/L), even if some acetic acid still occurred, since PHA production and storage was already verified and propionic acid was completely consumed. This allowed avoiding the relative decrease of the HV content. For this condition, the main single VFAs concentration profile as a function of the experimental time is shown in **Figure 5D**: propionic acid remained almost constant until butyric acid was depleted, then it started to be consumed at a higher rate (**Table 2**). Regarding the 50 % condition, Abs600, PHAs content and total VFAs concentration remained constant for about 24 h before the beginning of PHA accumulation. Related final cell concentration was 1.65 g CDW/L. Few propionic acid consumption and HV production were detected. To identify whether PHAs were produced from VFAs or other compounds occurring in the complex OMW_{Acid} matrix, initials and finals COD values were measured and COD depletions were compared with theoretical COD decays, which were calculated on the basis of VFAs consumption (by expressing single VFAs concentrations in grams of equivalent COD per liter, gCOD /L, according to stoichiometric calculations). The measured decreases of COD were 2.44 ± 0.50 gCOD/L and 3.54 ± 0.46 gCOD/L for 25 % and 50 % conditions, respectively. The calculated theoretical COD decays were: 2.25 ± 0.28 gCOD/L and 3.23 ± 0.35 gCOD/L, respectively.

2. POLYHYDROXYALKANOATES PRODUCTION FROM OLIVE MILL WASTEWATER

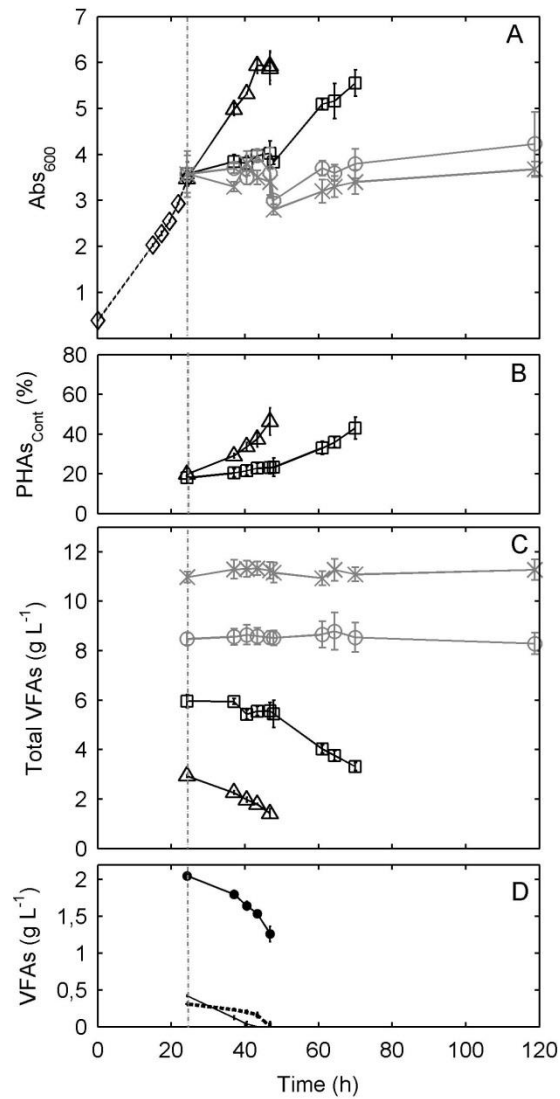

Figure 5: Time course profiles of main experimental parameters during the accumulation phase when OMW_{Acid} represented 25 (Δ), 50 (\square), 75 (\circ) or 100 % (\times) v/v of the accumulation medium: (A) Absorbance (Abs_{600}) values related to growth ($--\diamond--$) and accumulation phases; (B) PHAs content ($PHAs_{cont}$) related to accumulating conditions (%), (g/g); (C) Total VFA concentrations; (D) concentration of Acetic (\bullet), propionic ($---$) and butyric acids (\blacksquare) when OMW_{Acid} represented 25% of the flask working volume.

Table 2: Main performances of accumulation processes fed with 25 or 50% v/v of OMW_{Acid} , which led to PHAs accumulation: PHAs content ($PHAs_{cont}$) and yield ($Y_{PHAs/VFAs}$); specific HV content in the produced co-polymer (HV%); specific accumulation rate (Π_{Accum}); acetic, propionic

2. POLYHYDROXYALKANOATES PRODUCTION FROM OLIVE MILL WASTEWATER

and butyric acids consumption averages rates ($\Delta\text{Ac} / \Delta t$, $\Delta\text{Pro} / \Delta t$ and $\Delta\text{But} / \Delta t$, respectively); total VFAs consumptions ($\Delta\text{VFAs}_{\text{Tot}}$); final pH values.

OMW _{Acid}	25%	50%
PHAS _{Cont} (%)	46 ± 4	43 ± 2
HV % (mol HV / mol PHAs)	14 ± 3	8 ± 2
Y _{PHAs/VFAs} (g PHAs / g VFAs)	0.31 ± 0.05	0.22 ± 0.03
Π _{Accum} (h ⁻¹)	0.023 ± 0.001	0.012 ± 0.003 ^a (0.019 ± 0.003) ^b
ΔAc / Δt (g L ⁻¹ h ⁻¹)	0.035 ± 0.007	0.031 ± 0.005 ^a (0.058 ± 0.006) ^b
ΔPro / Δt (g L ⁻¹ h ⁻¹)	0.011 ± 0.002	0.006 ± 0.001 ^a (0.010 ± 0.002) ^b
ΔBut / Δt (g L ⁻¹ h ⁻¹)	0.022 ± 0.005	0.012 ± 0.001 ^a (0.018 ± 0.002) ^b
ΔVFAs _{Tot} ; 22h (g L ⁻¹)	1.60 ± 0.25	2.44 ± 0.27 ^b
pH _f	8.0 ± 0.1	7.9 ± 0.2

^a Calculated considering the whole accumulation phase

^b Calculated without considering the accumulation delay

2.4.2.2 PHAs ACCUMULATION WITHIN Sim_{VFAs}OMW_{Acid}

In order to verify if VFAs could have contributed to the previously observed inhibition of the PHA accumulation, a second experiment was carried out by replacing OMW_{Acid} with Sim_{VFAs}OMW_{Acid} solutions (from 25 to 100%, v/v). In this way, the same VFAs concentrations of those occurring in OMW_{Acid} accumulation media were tested. PHAs production was observed for all tested VFAs concentrations (**Table 3**). Accordingly, the increase of Abs₆₀₀ and pH values, along with total VFAs consumptions, were detected from the time the accumulation phase started and for the whole time course of the experiment (**Figure 6 A, B**). The last sampling for the 25 and 50% conditions showed that VFAs were completely consumed, and PHAs production was finished. In particular, no VFAs were further available after 44 h for the 25% condition (**Figure 6B**). This induced a consumption of the stored biopolymers, which were used as a carbon and energy source. Main results, including total VFAs consumptions related to the firsts 21 h of the accumulation phase (when all VFAs in the 25% condition were depleted), are shown in **Table 3**. Specific accumulation rates resulted inversely proportional to the Sim_{VFAs}OMW_{Acid} content. Furthermore, the single VFAs consumption profiles related to the 50% condition are shown in **Figure 6 C**, representing a typical observed behaviour: again, propionic acid consumption rate increased once butyric acid was depleted. The consumption rates of single VFAs varied with the Sim_{VFAs}OMW_{Acid} content: in particular, that of acetic acid started to slow down from 50% condition, the consumption rate of propionic acid decreased from 75 % condition, while that of butyric acid was almost the same under all tested conditions.

2. POLYHYDROXYALKANOATES PRODUCTION FROM OLIVE MILL WASTEWATER

Table 3: Main performances of accumulation processes fed with 25, 50, 75 or 100% v/v of $\text{Sim}_{\text{VFAsOMW}_{\text{Acid}}}$: PHAs content ($\text{PHAs}_{\text{Cont}}$) and yield ($Y_{\text{PHAs/VFAs}}$); specific HV content in the produced co-polymer (HV%); specific accumulation rate (Π_{Accum}); acetic, propionic and butyric acids consumption averages rates ($\Delta\text{Ac} / \Delta t$, $\Delta\text{Pro} / \Delta t$ and $\Delta\text{But} / \Delta t$, respectively); total VFAs consumptions ($\Delta\text{VFAs}_{\text{Tot}}$); final pH values.

$\text{Sim}_{\text{VFAsOMW}_{\text{Acid}}}$	25%	50%	75%	100%
$\text{PHAs}_{\text{Cont}}$ (%)	42 ± 3	53 ± 2	60 ± 2	38 ± 4
HV % (mol HV mol PHAs^{-1})	10 ± 2	16 ± 2	20 ± 2	22 ± 2
$Y_{\text{PHAs/VFAs}}$ (g PHAs g VFAs^{-1})	0.30 ± 0.02	0.30 ± 0.02	0.26 ± 0.04	0.19 ± 0.05
Π_{Accum} (h^{-1})	0.0397 ± 0.0043	0.0289 ± 0.0028	0.0094 ± 0.0002	0.0074 ± 0.0010
$\Delta\text{Ac} / \Delta t$ (g $\text{L}^{-1} \text{h}^{-1}$)	0.0793 ± 0.0057	0.0342 ± 0.0072	0.0290 ± 0.0011	0.0073 ± 0.0028
$\Delta\text{Pro} / \Delta t$ (g $\text{L}^{-1} \text{h}^{-1}$)	0.0143 ± 0.0003	0.0170 ± 0.0026	0.0098 ± 0.0005	0.0087 ± 0.0039
$\Delta\text{But} / \Delta t$ (g $\text{L}^{-1} \text{h}^{-1}$)	0.0296 ± 0.0047	0.0291 ± 0.0001	0.0330 ± 0.0028	0.0330 ± 0.0056
$\Delta\text{VFAs}_{\text{Tot}}$; 21h (g L^{-1})	2.67 ± 0.10	1.70 ± 0.40	1.05 ± 0.85	0.94 ± 0.60
pH _f	8.5 ± 0.1	8.9 ± 0.1	8.9 ± 0.2	8.8 ± 0.3

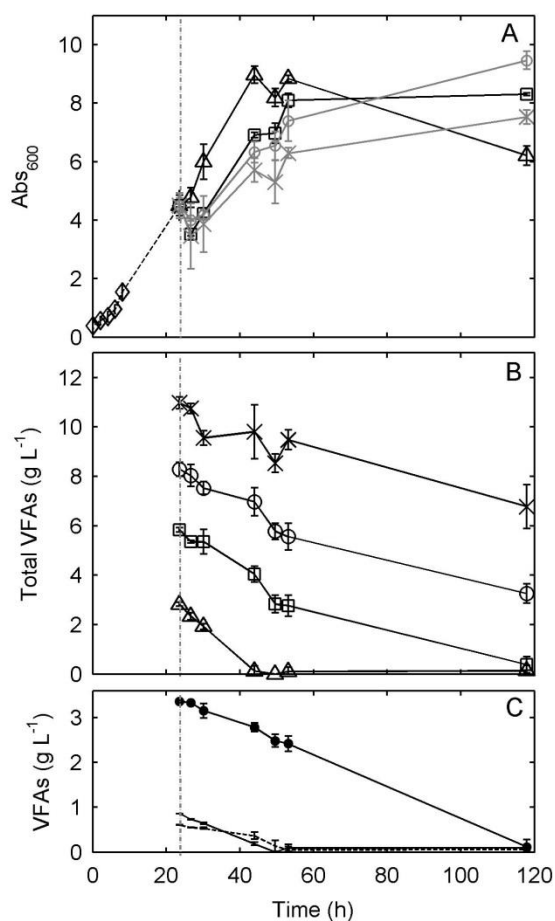

Figure 6: Time course profiles of main experimental parameters during the accumulation phase when $\text{Sim}_{\text{VFAsOMW}_{\text{Acid}}}$ represented 25 (Δ), 50 (\square), 75 (\circ) or 100% (\times) v/v of the accumulation medium: (A) Absorbance (Abs_{600}) values related to growth ($--\diamond--$) and accumulation phases; (B)

2. POLYHYDROXYALKANOATES PRODUCTION FROM OLIVE MILL WASTEWATER

Total VFA concentrations; (C) concentration of acetic (—●—), propionic (---) and butyric acids (—) when $\text{Sim}_{\text{VFAs}}\text{OMW}_{\text{Acid}}$ represented 50% of the flask working volume.

Importantly, this experiment carried out with VFAs solutions allowed to exclude VFAs as the main responsible of the former observed phenomenon: indeed, PHAs accumulation was observed under all conditions, including when $\text{Sim}_{\text{VFAs}}\text{OMW}_{\text{Acid}}$ represented 75 % and 100 % of the accumulation medium, while corresponding OMW_{Acid} amounts did not allowed significant PHAs productions. Lower performances in terms of specific accumulation rates and yields obtained under those latter conditions (Π_{Accum} and $Y_{\text{PHAs/VFAs}}$, **Table 3**) are coherent with previous studies, reporting VFAs inhibitory effects when their concentration values were between those of 50 and 75 % conditions [46,47]. Furthermore, consumption rates of single VFAs and specific accumulation rates related to $\text{Sim}_{\text{VFAs}}\text{OMW}_{\text{Acid}}$ content (**Table 3**) demonstrated that acetic acid exerted a higher toxicity, followed by propionic acid, while butyric acid seemed not to induce toxic effects. Higher HV contents were observed for the 75 % and the 100 % conditions. This evidence was assigned to the fact that the consumption ratio of propionic to acetic acid increased while increasing the $\text{Sim}_{\text{VFAs}}\text{OMW}_{\text{Acid}}$ content. In fact, the consumption rate of the acetic acid decreased up to 11.3 times if comparing the 25 % and 100 % conditions, while that of the propionic acid was only 1.5 times slower.

2.4.2.3 PHAs ACCUMULATION WITHIN $\text{Sim}_{\text{Phen}}\text{OMW}_{\text{Acid}}$

Concentration of polyphenols occurring in the accumulation medium containing 25 % of OMW_{Acid} (i.e., about 0.3 g L^{-1} of total polyphenolic compounds) was comparable to the upper concentration limit, over which such chemicals were expected to exert toxic effects to the employed *C. necator* strain [44,48]: thus, polyphenols probably contributed to the mentioned PHA accumulation delay (50 % condition) or absence (75 and 100 % condition). This hypothesis was tested by a dedicated experiment.

To this aim, the accumulation phase was done using a culture media containing an amount of total VFAs equal to 30 % of that occurring in OMW_{Acid} (previously demonstrated not to represent an inhibitory concentration) and different contents of the polyphenols mixture ($\text{Sim}_{\text{Phen}}\text{OMW}_{\text{Acid}}$ solutions). PHAs production was observed in all tested conditions. When polyphenols content represented 10% and 25% of total polyphenols contained in the actual OMW_{Acid} (0.12 and 0.30 g L^{-1} , respectively), the accumulation started immediately. Related last sampling showed that VFAs were completely consumed and PHAs did not accumulated further. Moreover, for the 10% condition even PHAs consumption was observed. This evidence was ascribed to the previous

2. POLYHYDROXYALKANOATES PRODUCTION FROM OLIVE MILL WASTEWATER

depletion of the carbon source, in agreement with what mentioned above for the $\text{Sim}_{\text{VFAsOMW}_{\text{Acid}}}$ 25 % condition. Higher polyphenols content negatively affected PHAs production: accumulation started at a lower rate for the 40 % condition (0.48 g L⁻¹ of total polyphenols), while no accumulation was observed for the 55 % condition (0.66 g L⁻¹ of total polyphenols) (**Figure 7A**). Total VFAs concentrations and PHAs content profiles were in agreement with such evidences (**Figure 7 B, C**); it was confirmed the role of polyphenols in the PHA accumulation inhibition.

Main results of the experiment carried out with $\text{Sim}_{\text{PhenOMW}_{\text{Acid}}}$ solutions are reported in **Table 4**. The specific accumulation rates related to the 40 % and 55 % conditions were about 58 % and 19 %, respectively, of that obtained when the lower polyphenols content was tested (10 % condition).

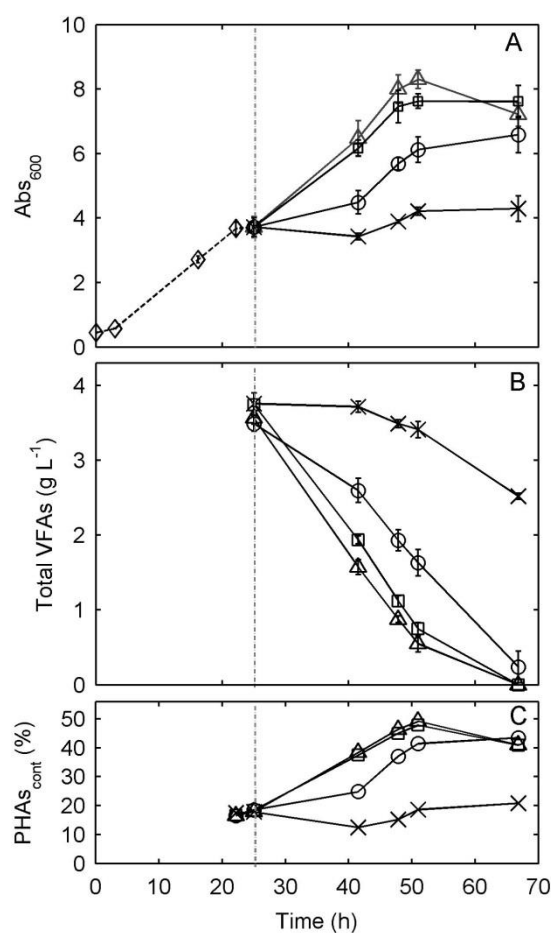

Figure 7: Time course profiles of main experimental parameters during the accumulation phase when $\text{Sim}_{\text{PhenOMW}_{\text{Acid}}}$ represented 10 % (Δ), 25 % (\square), 40 % (\circ) and 55 % (\times) v/v of the accumulation medium: (A) Absorbance (Abs_{600}) values related to growth ($--\diamond--$) and accumulation phases; (B) Total VFA concentrations; (C) PHAs content ($\text{PHAs}_{\text{cont}}$) related to accumulating conditions (% , g g⁻¹).

2. POLYHYDROXYALKANOATES PRODUCTION FROM OLIVE MILL WASTEWATER

Table 4: Main performances of accumulation processes fed with Sim_{Phen}OMW_{Acid} containing 10, 25, 40 or 55 % of total polyphenols occurring in OMW_{Acid}: PHAs content (PHAs_{Cont}) and yield ($Y_{\text{PHAs/VFAs}}$); specific accumulation rate (Π_{Accum}); acetic, propionic and butyric acids consumption averages rates ($\Delta\text{Ac} / \Delta t$, $\Delta\text{Pro} / \Delta t$ and $\Delta\text{But} / \Delta t$, respectively); total VFA consumptions ($\Delta\text{VFAs}_{\text{Tot}}$); initial (i) and final (f) cell concentrations (X); final pH values.

Total Polyphenol Content	10%	25%	40%	55%
PHAs _{Cont} (%)	49±2	48±2	43±2	22±2
$Y_{\text{PHAs/VFAs}}$ (g PHAs g VFAs ⁻¹)	0.28±0.01	0.26±0.01	0.23±0.02	0.10±0.02
Π_{Accum} (h ⁻¹)	0.0325±0.0012	0.0321±0.0018	0.0174±0.0028	0.0057±0.0018
$\Delta\text{Ac} / \Delta t$ (g L ⁻¹ h ⁻¹)	0.0676±0.0059	0.0652±0.0038	0.0488±0.0066	0.0149±0.0023
$\Delta\text{Pro} / \Delta t$ (g L ⁻¹ h ⁻¹)	0.0160±0.0004	0.0164±0.0001	0.0082±0.0002	0.0026±0.0004
$\Delta\text{But} / \Delta t$ (g L ⁻¹ h ⁻¹)	0.0311±0.0007	0.0325±0.0002	0.0190±0.0005	0.0086±0.0015
$\Delta\text{VFAs}_{\text{Tot}}$ (g L ⁻¹)	3.56 ± 0.08	3.74 ± 0.03	3.49 ± 0.10	1.20 ± 0.28
X _i (g L ⁻¹)	1.7±0.3	1.7±0.3	1.7±0.3	1.7±0.3
X _f (g L ⁻¹)	2.5±0.2	2.5±0.2	2.3±0.2	1.7±0.2
pH _f	8.6 ± 0.1	8.6 ± 0.1	8.2 ± 0.1	7.7 ± 0.1

2.4.2.4 PHAs ACCUMULATION BY APPLYING MULTIPLE BATCHES

The possibility of increasing the final PHAs content by performing two consecutive accumulation batch processes was tested with the OMW_{Acid} and Sim_{VFAs}OMW_{Acid} solutions, both employed at the 25 % condition. Results were also compared to those of a repeated single accumulation batch, which was carried with the 50% OMW_{Acid} and Sim_{VFAs}OMW_{Acid} solutions conditions, since they were fed with the same overall amount of carbon source. PHAs production and storage continued during the second accumulation batch process. In particular, a PHAs content of 55 and 60% w/w was obtained when OMW_{Acid} and Sim_{VFAs}OMW_{Acid} were fed, respectively (

Table 5). Results belonging to the OMW_{Acid} 50 % conditions strictly confirmed those reported in **Table 2**. As for the SimOMW_{Acid} 50 %, new cultures were launched also in order to get the maximum PHAs content, which was not detected in the experiment described within Section 3.2 because of the sampling frequency. Time course profiles of main process parameters related to this experiment and to the above mentioned 50 % conditions are reported in **Figure 8**.

Table 5: Main performances of accumulation processes fed with 25 % of OMW_{acid} and Sim_{VFA}OMW_{Acid} when two consecutive batch processes were applied: PHAs content (PHAs_{Cont})

2. POLYHYDROXYALKANOATES PRODUCTION FROM OLIVE MILL WASTEWATER

and yield ($Y_{PHAs/VFAs}$); specific accumulation rate (Π_{Accum}); acetic, propionic and butyric acids consumption averages rates ($\Delta Ac / \Delta t$, $\Delta Pro / \Delta t$ and $\Delta But / \Delta t$, respectively); total VFA consumptions ($\Delta VFAs_{Tot}$); initial (i) and final (f) cell concentrations (X); final pH values.

	Two sequential processes		Single process
	OMW _{Acid} 25%	Sim _{VFAs} OMW _{Acid} 25%	Sim _{VFAs} OMW _{Acid} 50%
PHAs_{Cont} (%)	55 ± 4	60 ± 2	59 ± 4
HV % (mol HV mol PHAs⁻¹)	11 ± 2	18 ± 1	20 ± 4
Y_{PHAs/VFAs} (g PHAs g VFAs⁻¹)	0.25 ± 0.04	0.26 ± 0.02	0.30 ± 0.05
Π_{Accum} (h⁻¹)	0.0222 ± 0.0011 (0.0079 ± 0.0013) ^a	0.0215 ± 0.0013 (0.0114 ± 0.0013) ^a	0.0190 ± 0.0006
ΔAc/Δt (g L⁻¹ h⁻¹)	0.0350 ± 0.0069 (0.0364 ± 0.0002) ^a	0.0641 ± 0.0032 (0.0344 ± 0.0002) ^a	0.0466 ± 0.0065
ΔPro/Δt (g L⁻¹ h⁻¹)	0.0142 ± 0.0023 (0.0064 ± 0.0003) ^a	0.0218 ± 0.0001 (0.0090 ± 0.0002) ^a	0.0162 ± 0.0024
ΔBut/Δt (g L⁻¹ h⁻¹)	0.0221 ± 0.0005 (0.0144 ± 0.0011) ^a	0.0282 ± 0.0002 (0.0150 ± 0.0005) ^a	0.0130 ± 0.0024
ΔVFAs_{Tot} (g L⁻¹)	2.98 ± 0.59	3.92 ± 0.27	3.34 ± 0.50
X_i (g L⁻¹)	1.3 ± 0.2	1.3 ± 0.2	1.3 ± 0.2
X_f (g L⁻¹)	2.0 ± 0.2	2.2 ± 0.1	2.2 ± 0.2

^a Related to the 2nd accumulation batch.

2. POLYHYDROXYALKANOATES PRODUCTION FROM OLIVE MILL WASTEWATER

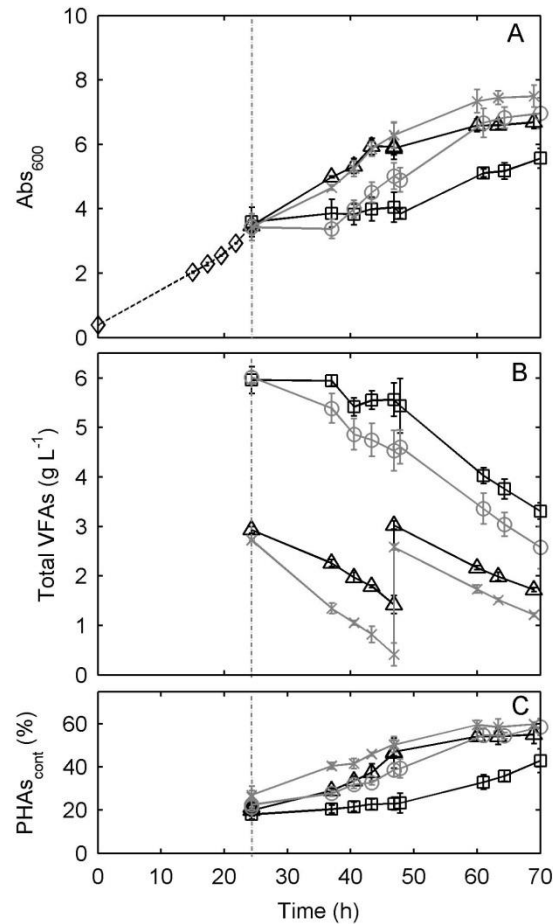

Figure 8: Time course profiles of main experimental parameters during the accumulation phase when OMW_{Acid} (\square) and $Sim_{VFAs}OMW_{Acid}$ (\circ) represented 50% v/v of the accumulation media; and when the same solutions represented 25% v/v of the accumulation media and two sequential accumulation batch processes were applied (Δ and \times , respectively): (A) Absorbance (Abs_{600}) values related to growth ($--\diamond--$) and accumulation phases; (B) Total VFA concentrations; (C) PHAs content ($PHAs_{cont}$) related to accumulating conditions (% , $g\ g^{-1}$).

The application of two consecutive accumulation batch processes with accumulation media containing 25 % of OMW_{Acid} and $Sim_{VFAs}OMW_{Acid}$ allowed significantly increasing the PHA content, which was obtained as the result of a single accumulation run. Notably, a comparison with the single batch tests fed with the same overall amount of substrate (50 % condition) demonstrated that the sequential batch process strategy can lead to the same final PHAs content (Fig. 4C). Such a result was more remarkable when the actual biowaste (OMW_{Acid}) was used. In that case, the PHAs content shifted from 43 to 55 % (**Table 2** and

2. POLYHYDROXYALKANOATES PRODUCTION FROM OLIVE MILL WASTEWATER

Table 5, respectively). This evidence was in agreement with the substrate inhibition, which was observed when OMW_{Acid} solutions represented the accumulation media. Furthermore, such PHAs content value was closed to that obtained by using the Sim_{VFAs}OMW_{Acid} solution (60 %, **Table 5**) and slightly higher than what obtained with the same laboratory prepared medium by the application of a single accumulation batch process fed with the same overall amount of substrate (53 %, **Table 3**). All this considered, and since VFAs concentration in the OMW_{Acid} would not allow performing a fed-batch culture system without decreasing the cell concentration, those evidences are of interest in the perspective of developing cell recycling processes in which feeding grown-cells until the obtainment of satisfactory PHAs accumulation yield, by avoiding at the same time inhibitory effects due to substrate concentration. The polymer production yield (grams of PHAs produced per grams of depleted VFAs), related to the 25 % OMW_{Acid} condition (single batch process) was lower than values previously published when pure acids were tested as the carbon source [49,50] ($Y_{\text{PHB/Acetic}} = 0.47 \text{ g g}^{-1}$ and $Y_{\text{PHB/Butyric}} = 0.65 \text{ g g}^{-1}$, respectively). However, it was comparable to that obtained when a fermented OMW and a mixed microbial culture were employed [51]. Moreover, it was higher than yields reported when palm oil mill effluent and a pure culture of *Rhodobacter sphaeroides* ($0.22 \text{ g PHAs} \cdot \text{g VFAs}^{-1}$) [13] or fermented organic waste and a pure culture of *R. eutropha* TF93 ($0.16 \text{ g PHAs} \cdot \text{g VFAs}^{-1}$) were used [52]. The production of a copolymer, which contained 11–14 % (on molar bases) of HV, was very interesting in terms of biopolymer post-production processability. As a matter of fact, pure PHB has limited applicability, since its melting and degradation temperatures are closed each other [9]. The HV yield ($Y_{\text{HV/Prop}}$, expressed as g of HV per g of consumed propionic acid) was similar to that obtained by using a laboratory prepared solution containing acetic, propionic and butyric acids so that relative concentrations were 60, 20 and 20 % (on molar bases), respectively: thus, in that case, the expected HV relative content (20 %) was not achieved [42]. This was assigned to the facts that (a) cells already contained a low amount of PHB at the end of the growth phase, and (b) part of the propionic acid could be used for HB formation. In this respect, HV content was lower than that reported in [52] (30 % on molar bases) but higher than that reported in [53] when fermented OMWs represented the substrate for PHA storage, which is the case of the present work. The HV content could be increased even more by inducing the anaerobic acidogenic digestion of the target biowaste to produce more VFAs with an odd number of carbons [54,55]. As recently referred, PHAs productions from OMWs and pure cultures of *Azotobacter sp.* were previously reported [56], even if an effluent with a very low VFAs content was employed (30 mg L^{-1} of total VFAs) [53]. However, such bacteria were unable to produce the copolymer poly(hydroxybutyrate-co-hydroxyvalerate) (Poly(HB-co-HV)) without the addition of valeric acid as an exogenous carbon source. The profile of VFAs consumption was

2. POLYHYDROXYALKANOATES PRODUCTION FROM OLIVE MILL WASTEWATER

comparable to that reported elsewhere [38], when VFAs were used for cell growth and PHAs production: butyric acid was firstly consumed, followed by propionic acid and acetic acid, respectively. Finally, the comparison between the measured and theoretical COD removals related to both accumulation conditions in the presence of OMW_{Acid} (25 and 50 % conditions) demonstrated that PHAs were mainly produced from VFAs, since the differences between such parameters are lower than the standard deviation errors.

2.4.3 INTEGRATED BIOREFINERY OF OMW FOR PRODUCING A POLYPHENOLS MIXTURE, BIOPOLYMER AND BIOGAS: *TECHNICAL FEASIBILITY STUDY*

The present work was dedicated to analyse the feasibility of valorising the OMW within a multi-purpose biorefinery. Results are presented in the order the processes-steps occurred.

2.4.3.1 CONTINUOUS POLYPHENOLS RECOVERY

The SPE was studied in deep by Prof. Pinelli's group, our study was in terms of general material balances for the biorefinery. SPE results are briefly presented. After the centrifugation step, the OMW was treated in continuous within a packed column. Polyphenols concentration and COD of samples along the breakthrough test were measured (**Figure 9**).

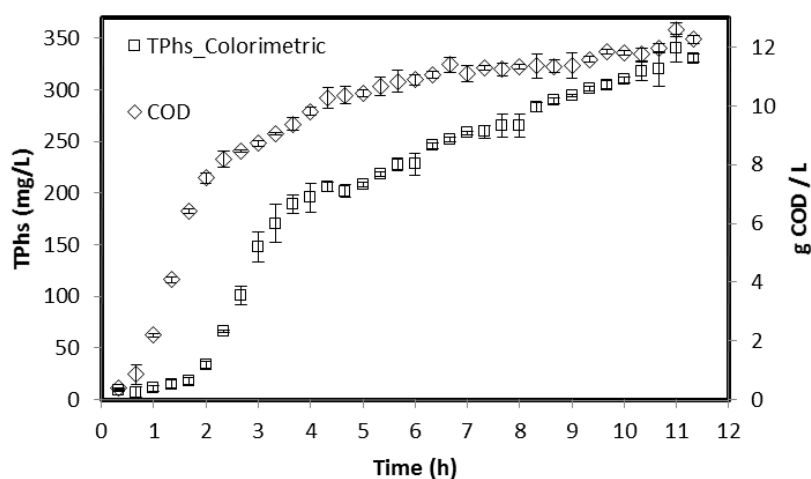

Figure 9: Dephenolisation break-through test. Samples taken from the exit stream of the column to analyse: total phenols content (TPhs) and COD. The presented values are the mean of three measurements and standard deviation is represented by error bars.

Regarding essential material balance, main effluent characteristics of the initial and pre-treated OMW are shown in **Table 6**. It can be seen that the required centrifugation step (for SPE) diminished the effluent material content in 8 ± 1.8 g COD \cdot L⁻¹. Indeed, 5.8 ± 2.4 g.L⁻¹ of suspended

2. POLYHYDROXYALKANOATES PRODUCTION FROM OLIVE MILL WASTEWATER

solids were removed and employed to produce biogas forward in the scheme. As for the dephenolisation efficiency, 603 ± 29 mg TPhs.L⁻¹ were removed (75% extracted).

Table 6: OMW 2013 original and post-dephenolisation characteristics.

	OMW _{Fresh}	OMW _{Centrifuged}	OMW _{Deph}
COD (gO ₂ .L ⁻¹)	26.0 ± 0.6	18.0 ± 1.2	11.4 ± 0.4
TS (g.L ⁻¹)	11.2 ± 1.8	5.4 ± 0.6	4.5 ± 0.8
pH	4.7 ± 0.1	4.7 ± 0.1	5.0 ± 0.1
TPhs (mg.L ⁻¹)	N.M	804 ± 15	201 ± 14
N-NH₄ (mg.L ⁻¹)	N.M	19.4 ± 1.2	12.3 ± 0.6

N.M: not measured

2.4.3.2 ANAEROBIC ACIDOGENIC DIGESTION OF OMW_{Deph,cont}

After polyphenols recovery, the OMW_{Deph,cont} still contained material. Even though the over left material concentration was less in comparison with the former applied batch dephenolisation, an anaerobic acidogenic digestion step was carried out to transform the complex molecules into simpler such as VFAs. The importance of the experiment relied on the potential use of a low TPhs content effluent for producing PHAs.

After 7 days the total VFAs concentration was 5.52 ± 0.11 g.L⁻¹ (7.7 gCOD.L⁻¹), mainly (g/L): acetic (2.45 ± 0.03), propionic (0.96 ± 0.02), butyric (0.89 ± 0.03), valeric (0.84 ± 0.02) and caproic (0.39 ± 0.03) acids. Important to mention, the OMW_{Fresh} contained 1.6 ± 0.2 g.L⁻¹ of ethanol, in accordance with OMW composition described elsewhere [57], and thus the OMW_{Deph,cont} contained ethanol; allowing to produce caproic acid by chain elongation.

The final OMW_{Acid} COD was 10 gO₂.L⁻¹, almost 80% of which was represented by VFAs.

2. POLYHYDROXYALKANOATES PRODUCTION FROM OLIVE MILL WASTEWATER

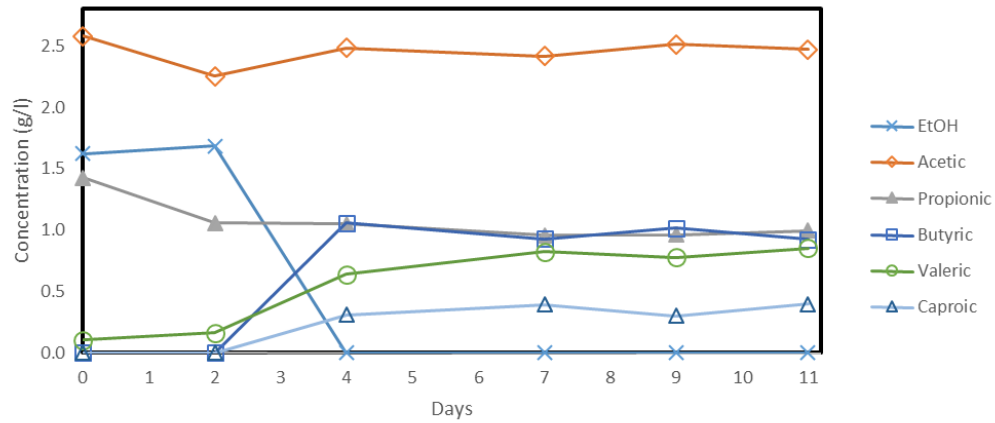

Figure 10: VFAs concentration trends along acidogenic batch process.

2.4.3.3 PHAs PRODUCTION FROM $OMW_{Deph,cont}^{Acid}$

The obtained results are presented in **Figure 11**. It can be seen that in both conditions the absorbance increased at similar rates, meaning that they started to accumulate immediately after initialising the accumulation phase and that no significant inhibition occurred when using 100 % v/v $OMW_{Deph,cont}^{Acid}$.

2. POLYHYDROXYALKANOATES PRODUCTION FROM OLIVE MILL WASTEWATER

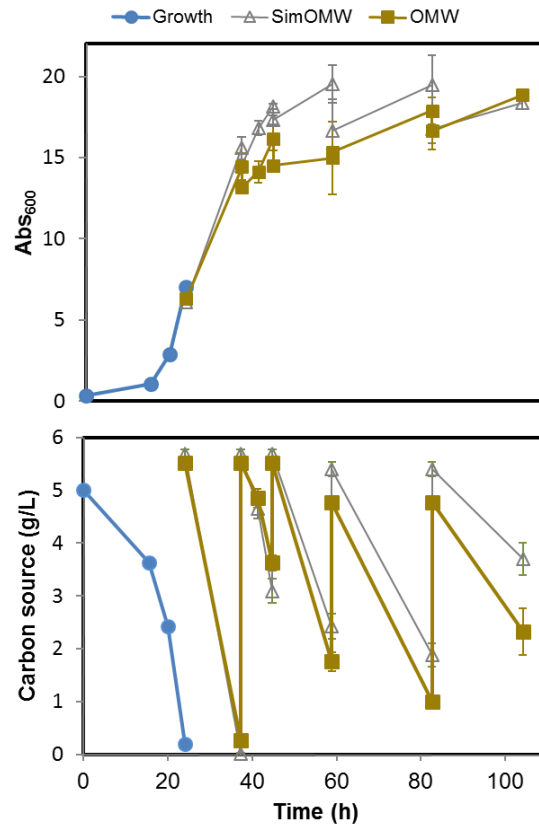

Figure 11: Time course profiles of main experimental parameters during the accumulation phase when OMW_{Acid} and $Sim_{VFAs}OMW_{Acid}$ represented 100 % v/v of the accumulation media. (A) Cell concentration in terms of absorbance (Abs_{600}) and (B) carbon substrate concentration -glucose and total VFA concentrations-; both related to growth and accumulation phases.

2. POLYHYDROXYALKANOATES PRODUCTION FROM OLIVE MILL WASTEWATER

Regarding the biopolymer production, results from TGA analyses from samples belonging to the beginning and end of the accumulation phase are shown in **Figure 12**. It can be seen that final PHAs contents were similar for both conditions; increased by 50 % during the accumulation phase.

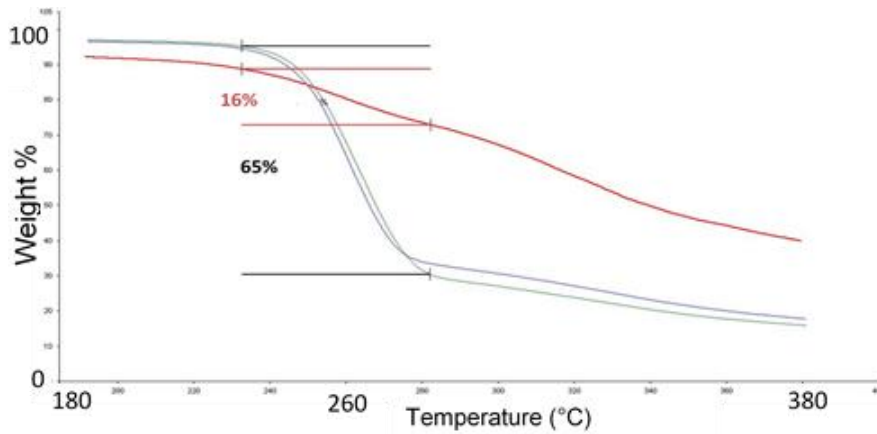

Figure 12: Thermo-gravimetric analysis of samples taken at the end of the growth phase (curve in red) and samples belonging to the end of the last accumulation batch (blue for OMW_{Acid} and green for $Sim_{VFAs}OMW_{Acid}$)

2.4.3.4 ANAEROBIC METHANOGENIC DIGESTION OF OMW_{Solid}

A first experiment allowed to confirm the possibility of using OMW_{Solid} as substrate for biogas production (**Figure 13**). After 30 days of digestion, $280 \text{ mL CH}_4 \cdot \text{g VS}_{\text{substrate}}^{-1}$ were produced,

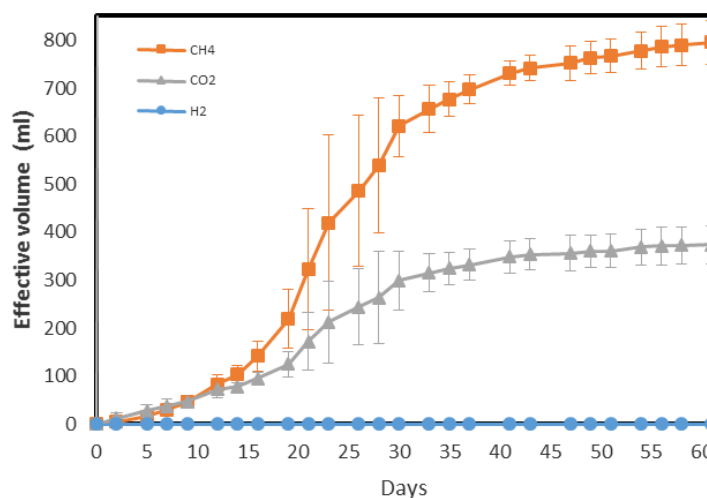

Figure 13: Effective biogas production using OMW_{Solid} as substrate.

2. POLYHYDROXYALKANOATES PRODUCTION FROM OLIVE MILL WASTEWATER

biogas was composed by (%): CH₄ (67.5), CO₂(32.49) and H₂ (0.01). The biomethane potential (BMP) after 60 days was 353±16 mL CH₄ . g VS_{sub}.

A second experiment was designed to study the kinetic of OMW_{Solid} digestion; useful when considering a potential scale-up study. To this aim, different concentration of OMW_{Solid} were tested; results are show in **Figure 14**. Biomethane production increase according the substrate concentration increase; from K1 to K6. The lowest and highest concentrated conditions (K1 and K7) did not produce at all. In the first case the little substrate amount do not allow to properly measure the effective biogas production, while for K7 condition it was inferred that substrate inhibition occurred. Indeed, when measuring the VFAs concentration at the end of the experiment, K7 contained 17.7 g . L⁻¹ of total VFAs.

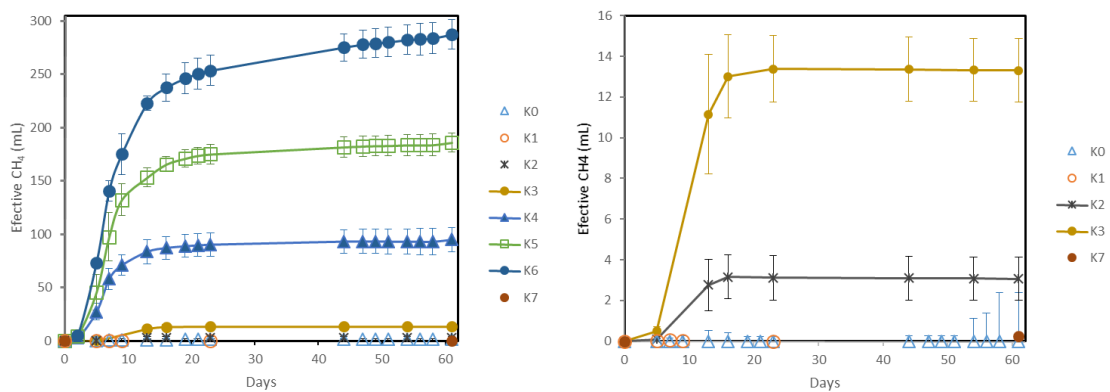

Figure 14: Biomethane production using OMW_{Solid} at different concentrations; from 0.064 (K1) to 99.5 (K7) g SV . L⁻¹ and K0 was the blank.

BMP (after 60 days) depended on the initial substrate concentration as shown in **Figure 15**; the trend includes the result obtained in the previous experiment (with 44 g SV . L⁻¹).

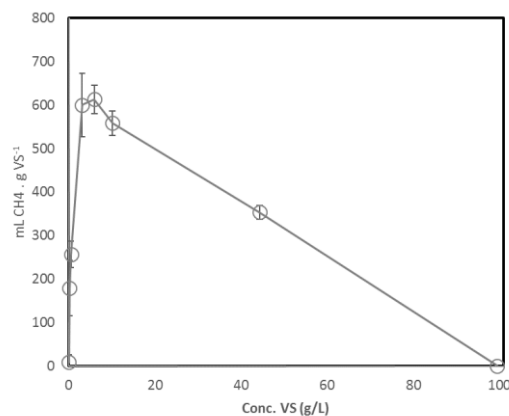

Figure 15: BMP after 60 days as a function of initial substrate concentration

The maximum specific rates of methane production (r_{CH_4}) were calculated for each condition (K1-K7). Considering that methane yield (mL CH₄ . g VS_{sub}⁻¹) is constant along the digestion, the

2. POLYHYDROXYALKANOATES PRODUCTION FROM OLIVE MILL WASTEWATER

substrate concentration when maximal rate occurred was calculated ($\Delta S = \frac{\Delta P}{Y_{p/s}}$). To do this, the yield used was $Y_{p/s} = 591 \pm 29 \frac{mL CH_4}{g VS_{sub}}$, which is the average of the BMP results obtained for conditions K4-K6. The resulting points were plotted (**Figure 16**, shown as black cross). It can be seen that point K7 (the red triangle) do not fit with Michaelis-Menten's model; this in accordance with the fact that the model do not consider inhibition by substrate. Trying to go a little further with the study, the result obtained in the first experiment -in which an intermediate concentration was used- was also plotted in **Figure 16** (the single grey triangle). It can be observed that digestion occurs at a notably lower rCH_4 , what allowed to inferred that inhibition by substrate starts at least from that tested concentration. In that first case VFAs concentration at the end of the digestion was not measured since testing a single condition no inhibition was detected; this showing the importance of doing a kinetic study. Even though an inhibition kinetic study would require more points to well-fit a model, a preliminary study was done using Aiba's model (**Figure 16**).

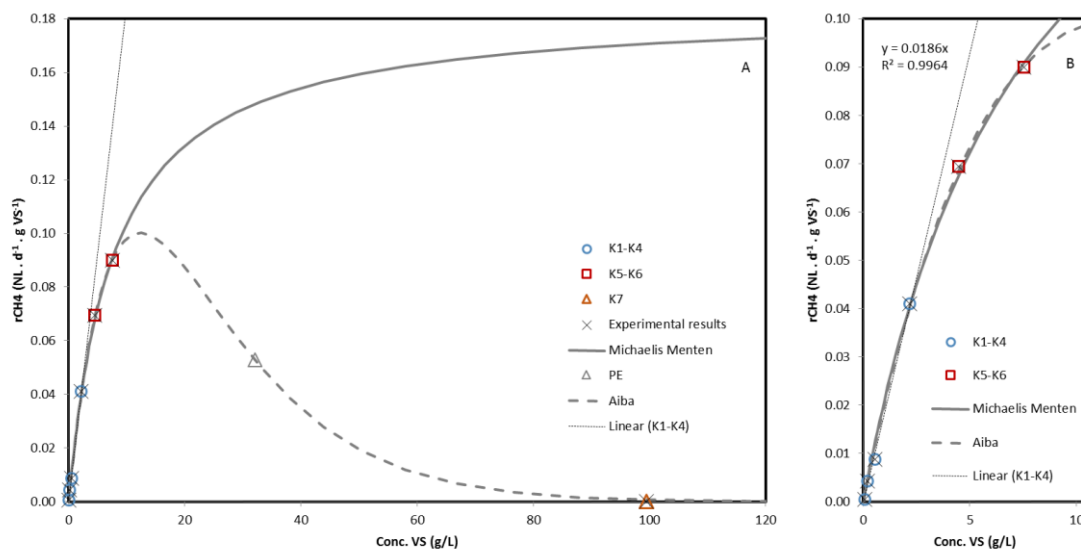

Figure 16: Specific rate of CH_4 production (rCH_4) as a function of substrate concentration. (A) Presented results are: experimental data obtained in the first (PE) and second experiment (K1-K7) and Michaelis-Menten and Aiba models fittings.

2.5 CONCLUSIONS

A dual-phase PHA production process was set up and carried out with a pure culture of *C. necator* as the biocatalyst. Grown cells were fed with an acid effluent, which was obtained by anaerobically digesting a pre-treated olive mill wastewater under acidogenic conditions (OMW_{Acid}). An accumulation of PHAs, which corresponded to 46 % (w/w) of the overall cell dry weight, was obtained when OMW_{Acid} represented $\frac{1}{4}$ of the accumulation phase medium. Even 55 % PHAs content (with an 11 % of HV) was achieved when two sequential batch processes were applied. Polyphenols contributed to inhibit the PHA accumulation process, while a good strain tolerance toward VFAs concentration was demonstrated. Furthermore, the production of the copolymer poly(3-hydroxybutyrate-co-3-hydroxyvalerate) with a significant relative amount of HV (11–14 %) was observed without adding any extra carbon source.

Regarding the utilization of a continuous dephenolised OMW, it was possible to produce PHB by implementing the acidic effluent at 100% v/v in the culture media.

All this considered, the obtained results are promising in the perspective of extending to the bench-top bioreactor scale the development of a PHAs production process based on the mentioned pure strain and feedstock. To the very best of our knowledge, the present investigation represents the first attempt to employ OMWs as the carbon source for the production of PHAs by using a pure culture of *C. necator*.

A biorefinery scheme could be defined for obtaining a polyphenol mixture and biopolymers. Finally, methanogenic digestion tests allowed to verify the possibility of producing a biogas (with high CH₄ content) from the OMW suspended solids.

3 POLYHYDROXYALKANOATES PRODUCTION FROM GRAPE POMACE

Summary The development of a multi-purpose four step-cascading biorefinery scheme for the valorization of red grape pomace (GP) was proposed. The consecutive processes were respectively dedicated to (a) the recovery of polyphenols by supercritical CO₂ extraction, (b) the production of volatile fatty acids (VFAs) by anaerobic acidogenic digestion, (c) the exploitation of produced VFAs as the precursors for the biotechnological production of polyhydroxyalkanoates (PHAs) and (d) the production of a CH₄-rich biogas by the anaerobic digestion of solid leftovers from the acidogenic process. Thereafter a second scheme was developed, in which the GP was directly (no defenolisation step) anaerobically digested. A stream high concentrated in hexanoic acid (>14 g/L) was obtained. From this, medium chain length PHAs were produced.

* Chapter adapted from *Gonzalo A. Martinez, Stefano Rebecchi, Deborha Decorti, Joana M. B. Domingos, Andrea Natolino, Daniele Del Rio, Lorenzo Bertin, Carla Da Porto and Fabio Fava, Towards multi-purpose biorefinery platforms for the valorisation of red grape pomace: production of polyphenols, volatile fatty acids, polyhydroxyalkanoates and biogas, Green Chem., 2016, 18, 261–270 [58]*

3.1 INTRODUCTION

According to an estimation reported by the OIV (International Organisation of Vine and Wine), 279 million hectolitres of wine were globally produced in 2014, 44.4 of which was produced in Italy [59]. Winemaking processes lead to the generation of significant amount of solid and liquid residues. In particular, grape pomace (GP), which represents the main solid winery waste, consists of about 50 % skin, 25 % stem and 25 % seed [60]. Considering that 18 kg of GP is generated on average per 100 L of wine produced [61], about 5 million tons of such residue are annually spawned worldwide, 0.8 of which is in Italy. According to a previous regulation (EC Regulation 1493/ 99), GP and lees of winery waste had to be processed by distilleries within the EU. Nowadays, a recent European reform in the wine sector (EC Regulation 479/2008) promotes the gradual withdrawal of distillation subsidies and consequently revokes the compulsory distillation. This should drive the promotion of integrated, sustainable and standardized alternative protocols for the valorisation of solid winery waste [60].

In this frame, the development of multi-purpose cascading biorefinery schemes fed with GP appears to be of great interest. This approach allows obtaining different valuable products by applying consecutive modular processes, along with a more extensive exploitation of organic leftovers, thus minimizing the generation of waste [62,63].

The extraction of bioactive compounds from GP can represent an option for valorising the residue. In particular, GP polyphenolic compounds can exert beneficial effects on human health [64] and they were found in the grape skin and seeds after the fermentation process for the production of wine. Their extraction from GP was already proposed for recovering highly valuable substances for the cosmetics, food additives (nutraceuticals) and pharmaceutical industries [63].

In particular, grape skins contain significant amounts of fibre (17 – 21%), fats (7 –12%), tannins (16 – 27%) and other polyphenolic compounds (2–6.5%), including catechins, anthocyanins, proanthocyanidins, quercetin, ellagic acid and resveratrol. Grape seeds, in addition to oil, contain approximately 60% of the polyphenols occurring in grapes, with high concentrations of flavan-3-ols, catechins and epicatechins [60]. However, the proposed recovery subtracts only a minor organic fraction.

An alternative valorisation of GP could be represented by the production of a methane-rich biogas by anaerobic digestion (AD) processes [65]. However, low biomethanization performances were generally achieved. This was ascribed to the high content of lignin, which is not readily fermentable. Moreover, *Fabbri et al.* [66] reported the detection of a significant lag phase during methane production. Inhibition by alcohols and phenols was proposed among

3. POLYHYDROXYALKANOATES PRODUCTION FROM GRAPE POMACE

possible explanations. Some preliminary GP anaerobic digestion tests, confirming scarce biomethanization of the waste, were carried out also in our labs. High volatile fatty acids (VFAs) production, and therefore their accumulation, was supposed as a further inhibitory cause [67]. On the other hand, VFAs, i.e., linear short chain (C₂–C₆) carboxylic acids, are functional molecules, which represent the precursors for the production of reduced added value chemicals (alcohols and aldehydes), polymers and biofuels in the frame of the carboxylate platform [68]. Thus, the acidogenic anaerobic digestion (AAD) of GP for the production of VFAs can be considered an alternative low-cost valuable approach for the valorisation of the biowaste.

Besides, VFAs are suitable precursors for the biotechnological production of polyhydroxyalkanoates (PHAs), which are microbial aliphatic polyesters naturally produced by many microorganisms. PHAs can exhibit similar or even better physicochemical properties with respect to those of petrol-based polyolefins [6–9]. Nowadays, PHAs are industrially produced by microbial pure cultures commonly fed with glucose [26]. Nevertheless, this approach hardly allows an economically competitive polymer production [2] when compared to that of petrol-based equivalent molecules, such as polypropylene. Alternative strategies based on the employment of mixed microbial culture (MMC) fed with VFA-rich effluents, which were obtained by digesting different biowastes under acidogenic conditions, were proposed with the aim of lowering the costs associated with the substrate and the process [18]. However, even the best results [69] showed that low PHAs concentrations can be obtained in MMCs effluents, and this negatively affects downstream costs. In addition to this, the employment of MMCs leads to a mixture of polymers instead of a well-defined single polymer type. Therefore, the development of new PHAs production processes mediated by pure cultures fed with VFAs-rich effluents appears to be of great interest [3].

Considering all this, the present work was dedicated to evaluate the technical feasibility of a multi-purpose cascading biorefinery scheme fed with a red GP for the obtainment of polyphenols, VFAs, PHAs and biomethane. Initially, it was proposed to study the scheme shown in **Figure 17**. In particular, a supercritical CO₂ extraction (SC-CO₂) was applied for the recovery of polyphenols. The resulting dephenolised GP (GP_{Deph}) was anaerobically digested under batch acidogenic conditions for the production of a VFA-rich liquid stream (GP_{Deph}^{Acid}). This liquid fraction was employed as the substrate for producing PHAs by a pure culture of *Cupriavidus necator*. Furthermore, the solid leftover from GP_{Deph}^{Acid} underwent a further methanogenic AD process dedicated to the production of a methane-rich biogas.

Beyond this study, a second integrated strategy for GP valorisation was proposed in which the GP is directly digested *-without dephenolisation step-* under acidogenic conditions. This strategy

3. POLYHYDROXYALKANOATES PRODUCTION FROM GRAPE POMACE

also includes the production of PHAs within *Pseudomonas putida* and biogas by employing the obtained VFAs-rich stream (GP^{Acid}) and the solid leftover remained from GP^{Acid} , respectively. To the very best of our knowledge, this is the first study dedicated to develop an integrated GP

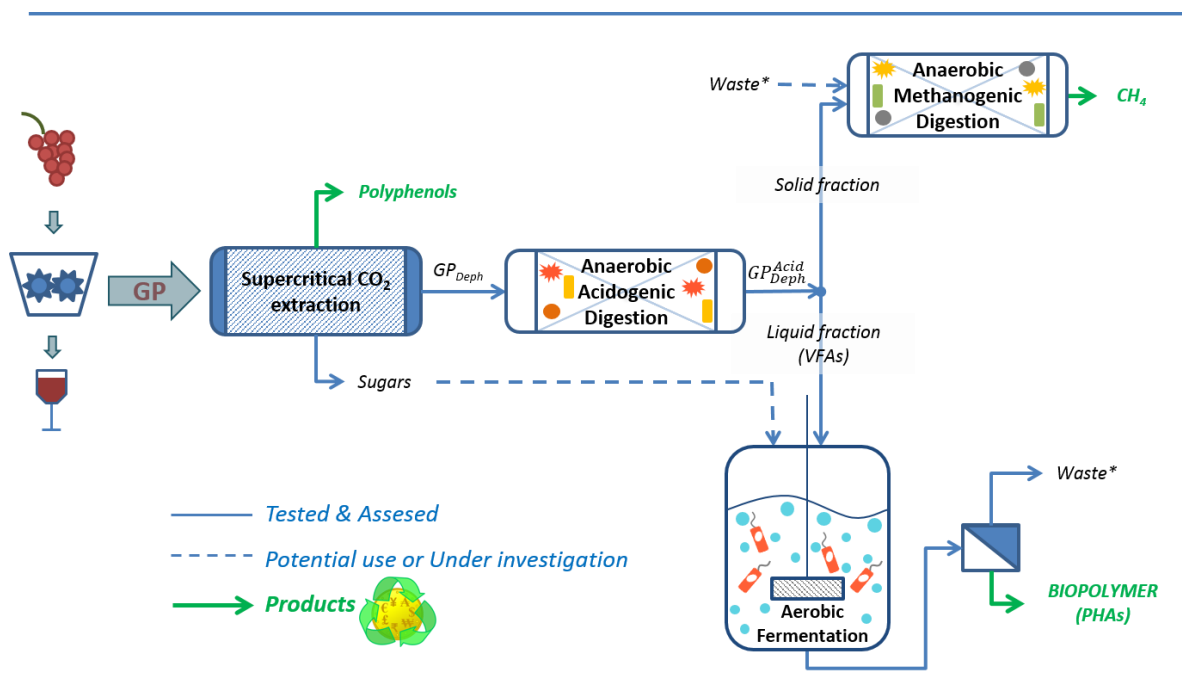

Figure 17: Multi-purpose biorefinery scheme for the obtention of polyphenols and biopolymer from red grape pomace (GP).

valorisation scheme. In particular, it represents the first attempts to produce short chain length and medium chain length PHAs within pure cultures of *C. necator* and *P. putida* by employing digested GP_{Deph} and GP, both respectively, as an alternative carbon source.

3.2 MATERIAL AND METHODS

3.2.1 CHEMICALS AND GRAPE POMACES

Folin–Ciocalteu reagent, gallic acid, (\pm)catechin, (+)- α -tocopherol, vanillin 99%, the standard volatile fatty acid (VFA) mixture (Supelco), poly(3-hydroxybutyric acid- co-3-hydroxyvaleric acid) (12 wt% PHV; natural origin), salts (BioReagent) for the mineral medium, single VFA and glucose (BioReagent) were purchased from Sigma Aldrich.

GP from red grape (*Vitis vinifera L.*) varieties were collected during September 2012 in the Friuli Venezia-Giulia region (Italy). It was air dried at room temperature (moisture $14.3\% \pm 0.3$ w/w)

3. POLYHYDROXYALKANOATES PRODUCTION FROM GRAPE POMACE

and stocked at 4 °C until use. It was ground with a domestic miller, with an average particle diameter of 0.83 ± 0.05 mm as calculated with Sauter's equation [70].

3.2.2 POLYPHENOLS EXTRACTION

The polyphenol recovery via supercritical CO₂ extraction was carried out using a commercial pilot-plant (SCF100 series 3 PLC-GR-DLMP, Separeco s.r.l., Pinerolo, Italy) equipped with a 1 L extraction vessel, two 0.3 L separators in series and a tank for CO₂ storage. The gas was recycled after the separation process. A simplified flow sheet of the SFE pilot plant is given in Figure 18.

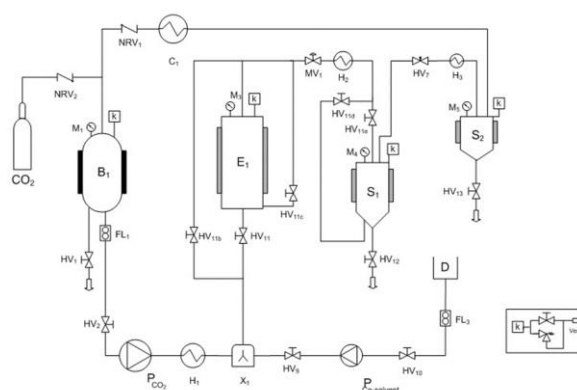

Figure 18: Schematic pilot-scale extractor: (B1) Storage tank, (E1) extraction vessel, (S1, S2) separators, (H#) heat exchangers; (C1) condenser; (HV#) Hand valves; (MV1) membrane valve; (NVR#) no return valves; (P) diaphragm pumps; (F1) flowmeter; (M#) manometers; (k) safety devices; (FL1) coriolis mass flowmeter; (D) co-solvent storage tank; (X#) mixer.

Ground GP was fed to the extractor (0.480 kg; density 600 kg m^{-3}) in order to be defatted by supercritical CO₂. As suggested by *Sovová et al.* [71] pressure was 28 MPa and temperature was 45 °C, while CO₂ flow rate was 10 kg h^{-1} and the total extraction time was 3 h. Such conditions corresponded to 62.5 Q (kg CO₂ per kg feed). Subsequently, a co-solvent was required for extracting polyphenols from the defatted GP, due to the polarity of polyphenols. Therefore, 0.1 kg of defatted GP were treated with supercritical CO₂ containing 10% ethanol–water mixture (57%, v/v) (EtW) as a co-solvent at 8 MPa, 40 °C and CO₂ flow rate of 6 kg h^{-1} [60]. Aliquots of grape extract were collected during extractions in volumetric flasks at intervals of about 30 min, to assess several data points for the overall extraction curves (OECs). The ethanol aqueous mixture was then removed from the extracts with a rotary evaporator (Buchi, B465, - Switzerland) at 45 °C. After solvent removal, extracts were weighed and analysed. All experiments were conducted in duplicate. The statistical significances of the differences

3. POLYHYDROXYALKANOATES PRODUCTION FROM GRAPE POMACE

between means were determined using Tukey's test with the level of significance set up at $p \leq 0.05$.

3.2.3 ANAEROBIC ACIDOGENIC DIGESTION OF GP_{Deph} or GP_{Fresh}

The anaerobic processes were inoculated with an acidogenic microbial consortium, which was obtained from an anaerobic treatment of organic fraction of municipal solid waste and acclimated to the acidogenic digestion of GP and exhausted in terms of VFAs production.

The GP_{Fresh} and the GP_{Deph} coming from the extraction step were characterized in terms of total solid content ($g\ TS\ g\ GP_{Deph/Fresh}^{-1}$) and volatile solid content ($g\ VS\ g\ TS^{-1}$).

Thereafter, a 1 L-Pyrex bottle (supplied with a tri-ports cap with silicone septum) was fed with water, GP_{Fresh} or GP_{Deph} and a microbial inoculum (10%, v/v), so that final working volume and TS content were 560 mL and 20% (w/v), respectively. Incubation conditions were: pH 7, 37 °C and 150 rpm. The process was monitored every 2–3 days for biogas and VFAs production. To the latter aim, 500 μ L-liquid samples were withdrawn. pH was corrected to 7 by the addition of 10 M NaOH after each monitoring process. During such operation, nitrogen was flushed to maintain anaerobic conditions. VS were determined at the end of the digestion in order to evaluate the amount of organic matter consumed during this step. The experiment was carried out in triplicate.

3.2.4 PHAs PRODUCTION

3.2.4.1 Bacteria strains, inoculums and culture media

3.2.4.1.1 PHAs from GP_{Deph}^{Acid}

Cupriavidus necator (DSMZ 545) pre-culture was started from agar plates and grown within 24 hours, in a 500 mL-Erlenmeyer flask containing 150 mL of LB; incubation conditions were 30 °C and 150 rpm [3].

The experiments were performed according to a dual-phase process (reported above). Briefly, PHAs accumulation was induced after a preliminary phase, during which cells were grown under optimal conditions. A slightly modified Medium 81 from DSMZ was employed for the cell balanced growth (growth phase); it contained 3 $g\ L^{-1}$ instead of 1 $g\ L^{-1}$ of $(NH_4)_2SO_4$. Glucose (5 $g\ L^{-1}$) was added as the sole carbon source. Conversely, an ammonia free-medium was employed for the subsequent PHAs accumulation phase. It was prepared by combining two sterilized stock solutions, namely: (a) the VFAs-rich effluent obtained by the acidogenic digestion of GP_{Deph} (GP_{Deph}^{Acid}), which was filtered (Whatman N11, 11 μ m), amended with Medium 81-DSMZ salts (except for $(NH_4)_2SO_4$) and autoclaved using special Beckman flasks allowing a subsequent

3. POLYHYDROXYALKANOATES PRODUCTION FROM GRAPE POMACE

centrifugation (8000 rpm, 4 °C and 25 minutes) under sterile conditions; and (b) distilled water amended with Medium 81- DSMZ salts (except for $(\text{NH}_4)_2\text{SO}_4$) at the same concentrations they occur in such a medium. The accumulation culture media were prepared by mixing the two stock solutions at different proportions, namely: 20 and 40% v/v of GP_{Deph}^{Acid} . In addition to this, a parallel control test was carried out using a simulated GP_{Deph}^{Acid} ($SimGP_{Deph}^{Acid}$), which was a VFA solution prepared by dissolving in distilled water the organic acids at the same concentrations as in GP_{Deph}^{Acid} . The control test was aimed at verifying whether other compounds than VFAs occurring in GP_{Deph}^{Acid} could affect PHA accumulation. Two sequential accumulation batch processes were carried out under all conditions with an initial pH of 7.2.

3.2.4.1.2 PHAs from GP_{Fresh}^{Acid}

Pseudomonas putida (KT 2440) pre-culture was started from agar plates and grown within 12 hours in a 500 mL-Erlenmeyer flask containing 150 mL of LB; incubation conditions were 30 °C and 180 rpm [72].

Two strategies were tested using GP_{Fresh}^{Acid} as substrate: 1- two stages and 2- one stage production. In the former strategies, cells were grown under balanced conditions, using a slightly modified Medium 81 from DSMZ [72]; it contained 4 g L⁻¹ instead of 1 g L⁻¹ of $(\text{NH}_4)_2\text{SO}_4$ and glucose (4.5 g L⁻¹) as carbon source. Thereafter, the same medium -but NH₄ free- was used to induce the PHAs accumulation. It was prepared by combining two sterilized stock solutions, namely: (a) the GP_{Fresh}^{Acid} liquid fraction, which was filtered (Whatman N11, 11 μm) and autoclaved using special Beckman flasks allowing a subsequent centrifugation (8000 rpm, 4 °C and 25 minutes) under sterile conditions; and (b) distilled water amended with Medium 81- DSMZ salts (except for $(\text{NH}_4)_2\text{SO}_4$) at the corresponding amounts to achieve after mixing the same concentrations they occur in such a medium. The accumulation culture media was prepared by mixing the two stock solutions at 15% of GP_{Fresh}^{Acid} , this in order to avoid accumulation inhibition by high hexanoic acid concentration.

For the production in one stage, glucose and the VFAs accruing in the GP_{Fresh}^{Acid} were present from the beginning. To do this, the culture media was prepared -as before- by combining two sterilized solutions, namely: (a) the GP_{Fresh}^{Acid} liquid fraction, which was filtered (Whatman N11, 11 μm) and autoclaved using special Beckman flasks allowing a subsequent centrifugation (8000 rpm, 4 °C and 25 minutes) under sterile conditions; and (b) distilled water amended with Medium 81- DSMZ salts (including the $(\text{NH}_4)_2\text{SO}_4$) at the corresponding amounts to achieve after mixing the same concentrations they occur in such a medium. Also this time, the culture media was prepared by mixing the two stock solutions at 15% of GP_{Fresh}^{Acid} , this in order to avoid accumulation inhibition by high hexanoic acid concentration.

3. POLYHYDROXYALKANOATES PRODUCTION FROM GRAPE POMACE

In addition to this, parallel control tests were carried out for each strategy using a simulated GP_{Fresh}^{Acid} ($SimGP_{Fresh}^{Acid}$), which was a VFA solution prepared by dissolving in distilled water the organic acids at the same concentrations they occur in GP_{fresh}^{Acid} . The control tests were aimed at verifying whether other compounds than VFAs occurring in GP_{fresh}^{Acid} could affect PHAs accumulation.

3.2.4.2 Experimental approach

3.2.4.2.1 PHAs from GP_{Deph}^{Acid}

The whole PHAs production process was separated in a two-stage batch cultivation procedure. A growth phase (1st process phase) was carried out under balanced growth conditions, using glucose as the carbon source, and it was started by inoculating 500 mL-Erlenmeyer flasks containing 150 mL of the growing culture media. To this aim, pre-grown cells were harvested by centrifugation (6000 rpm for 5 minutes at 4 °C) and suspended in the media to an initial absorbance (Abs₆₀₀) of 0.4. The incubation conditions were the same as previously mentioned. After 24 hours, the growth phase was concluded and cells were harvested by centrifugation (6000 rpm for 5 minutes at 4 °C). Thereafter, the grown biomass was re-suspended in the experimental accumulation medium at the same concentration they occurred at the end of the growth phase, this representing the beginning of the subsequent PHA accumulation phase (2nd process phase). In this way, the possibility of using GP_{Deph}^{Acid} as an alternative carbon source specifically only for PHAs production was studied. The latter acid effluent constituted 20% and 40% of the accumulation phase media, as reported previously, in order to determine if GP_{Deph}^{Acid} concentration could affect the PHAs accumulation activity of grown cells. Each experiment was carried out in triplicate.

3.2.4.2.2 PHAs from GP_{Fresh}^{Acid}

The production in two stages was carried out as previously mentioned in Section 3.2.4.2.1, with the difference that the growth phase finished after 13 hours.

Regarding the second strategy, the production in one stage, experiment started with the culture media already containing 15% v/v of GP_{Fresh}^{Acid} (together with glucose) and therefore no centrifugation and resuspension was required.

3.2.5 BIOGAS PRODUCTION

3. POLYHYDROXYALKANOATES PRODUCTION FROM GRAPE POMACE

The solid leftover from the anaerobic acidogenic digestion step ($GP_{Deph,Solid}^{Acid}$ or $GP_{Fresh,Solid}^{Acid}$) was tested as a substrate for biogas production. The experiments were carried out in 100 mL Pyrex bottles (microcosms, 55 mL of working volume) tightly closed with a modified Pyrex-cap that allowed gas sampling. The inoculum to substrate ratio was 1 g of VS in the inoculum per g VS in the substrate, and the TS content was 8% (92% of which VS). The methanogenic microbial consortium employed as inoculum was obtained from a commercial biogas production plant located in the Emilia Romagna Region (Italy) fed with agro-industrial wastes and zootechnical liquor. It was exhausted in terms of gas production before being employed. The incubation conditions were 37 °C and 150 rpm. The experiment was carried out in triplicate. A blank control experiment was set up by filling microcosms only with water and the inoculum, in order to calculate the effective biogas production by subtracting the amount of biogas eventually produced within control experiments to that produced within target test. Biogas production was measured every 2–3 days. After biogas sampling, the bottles were opened under nitrogen gas flux to keep anaerobiose and pH was corrected to 7.5 by adding few drops of 10 M H₂SO₄. All the adopted experimental conditions were recommended by [28,29].

3.2.6 ANALYTICAL PROCEDURES

Polyphenols extraction. All procedures were carried out as previously described [60].

The total phenolic content (TPhs) of the extracts was measured using the Folin–Ciocalteu reagent, according to [73]. A calibration curve was obtained with standard solutions of gallic acid in the range 0.2–10 mg mL⁻¹ and measurements were carried out at 765 nm ($R^2 = 0.99$). Results were expressed as milligrams of equivalent gallic acid per 100 gram of dried matter (mgGAE per 100 gDM).

The fractionation of proanthocyanidins from the extracts was conducted as reported by ref. [74], as well as the total flavan-3-ol content that was determined by the vanillin assay. Results were expressed as milligrams of equivalent catechin acid per 100 g of dried matter (mgcatechin per 100 gDM).

The antioxidant activity of the phenolic extract and proanthocyanidin fraction was evaluated by the total free radical scavenger capacity (RSC) following the methodology described by ref. [75] with slight modification.² The antioxidant activity of the samples was expressed as the milligrams of α -tocopherol per 100 g of dried matter (mg α -tocopherol per 100 gDM). A calibration curve was obtained with standard solutions of α -tocopherol in the range 5.8×10^{-5} – 2.3×10^{-3} mol L⁻¹ ($R^2 = 0.98$).

All analyses were performed in triplicate.

3. POLYHYDROXYALKANOATES PRODUCTION FROM GRAPE POMACE

The qualitative characterization of polyphenolic extracts was carried out by UHPLC-MSⁿ analyses as reported by *Bresciani et al.* [76].

VFAs determination. VFA concentrations were determined by GC-FID analysis (Agilent 7890A). A HP-INNOWAX column (ID 0.25 mm, length 30 m and film thickness 0.25 μm) was employed under the following conditions: injector and FID temperature were 250 °C and 280 °C, respectively; pressure was 9.5649 psi; H₂ flow was 30 mL min⁻¹; air flow was 300 mL min⁻¹; carrier gas flow rate (nitrogen) was 29.281 mL min⁻¹, with a split ratio of 10 : 1 (7 mL min⁻¹); injection volume was 1 μL. The temperature programme was: 80 °C for 0.5 min, then 20 °C min⁻¹ to 150 °C for 1 min, then 20 °C min⁻¹ to 240 °C for 2.5 min. Before the analyses, the samples were diluted with an equal amount of a 60 mM oxalic acid solution.

At the end of the fermentation, organic matter content in the liquid phase was measured by determining chemical oxygen demand (COD) of the sample supernatant experimentally and theoretically, therefore obtaining the percentage of the total COD content that was ascribed to the occurrence of VFAs $\left(\frac{COD_{VFAs}}{COD_{Total}} * 100\%\right)$.

TPhs in the GP_{Deph}^{Acid} was measured by colorimetry with a down-scaled procedure of the method reported elsewhere. [35]

Chemical oxygen demand (COD). A colorimetric commercial kit (AQUALYTIC Vario MR) was used. At the same time a theoretical COD was calculated by only taking into account the VFA oxidation: concentrations were expressed as COD equivalents according to stoichiometric calculations.

PHAs production. Sampling was performed periodically. The procedures for sample treatment and analysis were the same as previously described in ref. [3].

When performing the Abs₆₀₀ vs. cell dry weight (CDW) calibration curve, linear correlations were obtained for the growth and the accumulation phases (data not shown). PHA content was defined as $\frac{g_{PHAs}}{g_{CDW}} * 100\%$, on a cell dry weight basis.

Organic matter consumption during the accumulation phase was followed by measuring the sample supernatant COD and the theoretical COD variation was calculated.

Biogas production was measured in terms of volume (glass syringe) and composition. This, in terms of H₂, O₂, CH₄ and CO₂, was measured by gas-chromatography using a μGC (model 3000 A – Agilent Technologies, Milano, Italy) under the following conditions: injector temperature 90

3. POLYHYDROXYALKANOATES PRODUCTION FROM GRAPE POMACE

°C; column temperature 60 °C; sampling time 20 s; injection time 50 ms; column pressure 25 psi; run time is 44 s and the carrier gas was nitrogen.

TS were determined by conventional gravimetric method exposing the sample to 105 °C overnight and VS were determined by exposing the resulting dried sample to 600 °C for 1 hour.

3.3 RESULTS AND DISCUSSION

Several approaches dedicated to the valorisation of grape pomace were reported in the literature, as reviewed by *Scoma et al.*[63]. However, most of these processes would hardly be economically feasible at an industrial scale if singularly applied. Conversely, multi-purpose integrated biorefinery could generate some positive synergistic effects, such as (a) cost investment optimization by better exploiting the diverse equipment, (b) diversification of the incoming profits by covering multiple markets/niches, (c) sharing manpower, (d) minimizing waste generation and (e) reaching energy self-sufficiency (e.g. biogas production from waste streams). This strategy could lead to an overall economic sustainability of the employment of biowaste as an innovative renewable and low-cost feedstock. [77] In this frame, olive pomace was recently proposed as a raw material for the integrated production of natural antioxidants and renewable energy [78]. Moreover, the potential beneficial effects of multi-purpose biorefineries could be further enhanced if more than one waste is valorised. At the same time, this may also represent a solution for the valorisation of seasonal biowaste. As an example, the extraction of polyphenols from olive pomace and GP would allow the facility to run all over the year.

According to the mentioned strategy, the present work represents an attempt to evaluate the possibility of valorising a red GP by the integrated production of natural antioxidants, biopolymers and biogas. The four processes included in the proposed GP biorefinery scheme were studied separately and sequentially, in agreement with the cascade approach. Experiments were performed at the bench-top/flask scale. Results are therefore presented according to the same processes and sequence order.

3.3.1 POLYPHENOLS EXTRACTION

The extraction of polyphenols from GP was studied by using: (a) supercritical carbon dioxide (SC-CO₂) containing 10% ethanol aqueous mixture at 57% (v/v) (SC-CO₂ + 10% EtW) and (b) conventional methanol extraction. The results for both methods are reported in **Table 7**. The process efficiency is quantitatively related to extraction yield. No statistically significant

3. POLYHYDROXYALKANOATES PRODUCTION FROM GRAPE POMACE

difference ($p \leq 0.01$) in the global yield of recovered dry matter (expressed as extracted mass per fed mass) obtained by SC-CO₂ and by methanol extractions was highlighted (**Table 7**).

Table 7: Chemical composition of GP extracts obtained by methanol and SC-CO₂ + 10% EtW extraction methods

	EXTRACTION METHODS	
	Methanol	SC-CO ₂ + 10% EtW
Global Yield (% w/w)	15.6 ± 1.2 a*	14.6 ± 1.5 a
Total Phenols (mg _{GAE} 100 g ⁻¹ _{DM})	2813 ± 10.8 a	2527 ± 11.5 b
Phenolic Yield (g _{GAE} kg ⁻¹ _{extract})	180.3 ± 0.4 a	173.1 ± 0.5 b
Phenolic Yield (% SC-CO ₂ /methanolic yield)	100	90
Total Antioxidant Activity (mg _{α-tocopherol} 100 g ⁻¹ _{DM})	678 ± 15.5	8703 ± 17.5
Proanthocyanidins (mg _{catechin} 100 g ⁻¹ _{DM})		
Monomeric fraction	1.2 ± 0.2	188.0 ± 3.8
Oligomeric fraction	4.1 ± 0.1	154.2 ± 5.8
Polymeric fraction	153.7 ± 0.2	361.5 ± 18.6
Antioxidant Activity (mg _{α-tocopherol} 100 g ⁻¹ _{DM})		
Monomeric fraction	28.1 ± 1.2	808.7 ± 10.2
Oligomeric fraction	30.1 ± 2.4	545.8 ± 7.3
Polymeric fraction	600.5 ± 2.9	3675.5 ± 6.8

Each data represent the mean of three replicates ± SD

* Values with different letter within row indicate significant differences ($p \leq 0.05$)

The application of the SC-CO₂ extraction allowed recovering 90% of the total polyphenols recovered within the conventional solvent method. The yield was higher than that reported by *Fariás et al.* [79] (2200 mg_{GAE} per 100 g_{DM}), as well as the total antioxidant activity.

The obtained results indicate that the extracts recovered by the application of both methods contained a large number of soluble compounds, and that GP polyphenols included flavonoids and non-flavonoids. [80] Among the former ones, catechins and their oligomeric and polymeric forms, and procyanidins (PCs), have been reported to exert potential health benefits in humans.[81] The healthy properties of catechins and PCs may depend on their structure and on their degree of polymerization. Monomeric structures have been shown to be quite efficiently absorbed, while oligomers reach the large intestine where they are efficiently converted into smaller metabolites by the local colonic microbial community.[82] In the present work, the amount of total catechins and PCs obtained by SC-CO₂ was 703.7 mg of catechin equivalents per 100 gDM, and monomeric and oligomeric fractions together represented about half of total

3. POLYHYDROXYALKANOATES PRODUCTION FROM GRAPE POMACE

extracted flavan-3-ols. In particular, the small size oligomeric fraction was composed of several dimeric, trimeric and tetrameric B-type PCs (see ESI Table S1 and Fig. S1[†]).

The SC-CO₂ polyphenol extraction from GP was recently demonstrated to allow better performances with respect to those of a conventional solvent-based approach.[60] In fact, even if the total polyphenol extraction yields were nearly the same, the antioxidant activity was one order of magnitude higher when using the SC-CO₂. Yet more important, the SC-CO₂ extract presented a higher level of total proanthocyanidins (PAs) with monomeric and oligomeric fractions (**Table 7**). This suggests that supercritical CO₂ extraction of PAs from GP is more selective in extracting proanthocyanidin fractions – beneficial for human health – than methanol extraction. Finally, it is worthy of note that about 60% of the total antioxidant activity resulted due to PAs in SC-CO₂ + 10% EtW, and 97 % in the conventional extraction. This evidence, together with the previous observation indicate that the supercritical operating conditions developed are able to extract not only selectively the PAs, but also a great amount of other antioxidant compounds, not extractable with the conventional method.

3.3.2 VFAs PRODUCTION

3.3.2.1 VFAs FROM GP_{Deph}

After polyphenol extraction, the dephenolised leftover (GP_{Deph}) contained 90 % of total solids (TS). Volatile solids (VS) were 90% of the latter fraction. The application of a batch anaerobic acidogenic wet process onto such an organic matter allowed the accumulation of a mixture of VFAs in the liquid phase. The VFAs concentration profile as a function of the experimental time

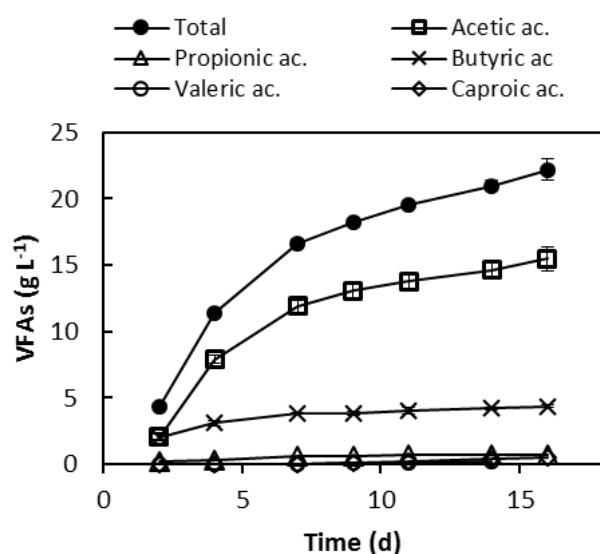

Figure 19: VFAs production from GP_{Deph} . Single and total VFA concentration trends.

3. POLYHYDROXYALKANOATES PRODUCTION FROM GRAPE POMACE

is shown in **Figure 19**. The whole AAD lasted 16 days, after which $22.2 \pm 0.8 \text{ g L}^{-1}$ of total VFAs were obtained, corresponding to 111 g of total VFAs per kilogram of GP_{Deph} . Among the produced acids, acetic (15.5 g L^{-1}) and butyric (4.3 g L^{-1}) mainly accumulated in the medium. At the end of this process the measured COD of the dephenolised and acidified effluent (GP_{Deph}^{Acid}) was $35 \pm 1 \text{ g COD L}^{-1}$. Since the COD due to the occurrence of VFAs (according to stoichiometric calculations) was $28.5 \pm 1.5 \text{ g COD L}^{-1}$, more than 80 % of the organic matter was represented by the target VFAs.

The final VFAs concentration was comparable to that reported in a study where vinasse was used for VFAs production (19 g L^{-1} of total VFAs).[83] Furthermore, comparable VFAs' overall concentration was obtained when the same process was carried out using non-dephenolised GP as the substrate (about 23 g L^{-1} , see ESI Fig. S2⁺). Taken together, such evidence seems to demonstrate that the preliminary polyphenol extraction process did not significantly lower the potentialities of the acidogenic step, probably both because a large availability of readily biodegradable organics still occurred in the GP_{Deph}^{Acid} and the biological process is inhibited by higher overall VFAs concentrations.

9 mL g VS^{-1} of biogas were produced all through the anaerobic acidogenic digestion. Importantly, no VFAs-consuming methanogenic activity was detected, while the overall produced biogas was composed of H_2 (35 %) and CO_2 (65 %). The total polyphenol content of the VFAs-rich liquid stream was $447 \pm 39 \text{ mg L}^{-1}$.

The over left solid fraction (the pellet after centrifugation) contained $30.1 \pm 0.7 \%$ TS and $91.6 \pm 0.5 \%$ VS.

3.3.2.2 VFAs FROM GP_{Fresh}

Previous results obtained at the acidogenic digestion of OMW containing ethanol, suggested that a high content ethanol matrix would allow to produce a VFAs-rich stream with high hexanoic acid concentration. GP_{Fresh} contains high amount of ethanol since it arrives from the wine production. Therefore, an anaerobic acidogenic digestion experiment was carried out using this agro-industrial residue; results are shown in **Error! Reference source not found.**. After 10 days $21.9 \pm 0.5 \text{ g.L}^{-1}$ of total VFAs were produced. No VFAs-consuming methanogenic activity was detected, neither from the biogas composition trend (data not shown) nor from the VFAs concentration trends. The obtained VFAs composition is compared with the mix obtained previously from GP_{Deph} in **Table 8**.

3. POLYHYDROXYALKANOATES PRODUCTION FROM GRAPE POMACE

Table 8: VFAs mixtures compositions obtained using GP_{Deph}^{Acid} and GP^{Acid} .

	GP_{Deph}^{Acid}	GP^{Acid}
Acetic ac. (g.L ⁻¹)	15.5±0.6	4.4±0.2
Propionic ac. (g.L ⁻¹)	0.8±0.0	0.35±0.1
Butyric ac. (g.L ⁻¹)	4.3±0.2	3.5±0.2
Valeric ac. (g.L ⁻¹)	0.2±0.0	0.97±0.02
Hexanoic ac. (g.L ⁻¹)	0.5±0.0	14.0±0.4
Total VFAs (g.L ⁻¹)	22.2±0.8	22.3±0.3

Originally, the GP contained 43.2±0.1 % of TS and 93.3±0.1 %. After the acidogenic digestion and liquid separation by centrifugation, the over left solid (pellet obtained after centrifugation) contained 29.8±1.0 % of TS and 91.2±0.5 %.

3.3.3 PHAs PRODUCTION

3.3.3.1 PHAs FROM GP_{Deph}^{Acid}

Low cost substrates and high polymer amounts per cell dry weights are required in order to persecute economic sustainability of biotechnological PHAs production. As a matter of fact, *C. necator* was found to grow and produce the biopolymer from diverse carbon sources.[3,12,36–40] Among winery waste, wine lees were used as supplementary medium [84] and enzyme pretreated GP (saccharified) was used as a carbon source.[85] However, acidified pre-treated GP was never tested as the substrate for the biotechnological production of PHAs. Recently, an effective two-step strategy for the production of PHAs from acidified olive mill wastewater by *C. necator* was proposed.[3] In that work, the advantages of employing a two-stage production process (constituted by a preliminary balanced growth using glucose as the carbon source and a consecutive PHAs accumulation step under NH₄ limiting conditions by feeding grown cells with VFAs) were discussed. Briefly, the employment of a low-cost alternative carbon source for the accumulation phase would allow replacing a large majority of the costly sugar required by the conventional PHA production process. In fact, PHAs may represent over 80% of the total CDW of *C. necator* strain.[4,26] Hence, the same approach was applied in this work, where grown cells of *C. necator* were fed (a) with different concentrations of the GP_{Deph}^{Acid} liquid fraction or (b) with aqueous solutions containing the same amount of VFAs occurring in the mentioned experimental VFA-rich substrates.

3. POLYHYDROXYALKANOATES PRODUCTION FROM GRAPE POMACE

During all experiments, the preliminary growth phase lasted 24.5 hours. The final cell concentration was $2.5 \pm 0.3 \text{ g L}^{-1}$ and the glucose consumption was $5.0 \pm 0.1 \text{ g L}^{-1}$. Thereafter, cells were harvested and re-suspended in the corresponding medium of each experimental test. PHAs accumulation was observed for all conditions as a linear increase of Abs600 (**Figure 20A**).

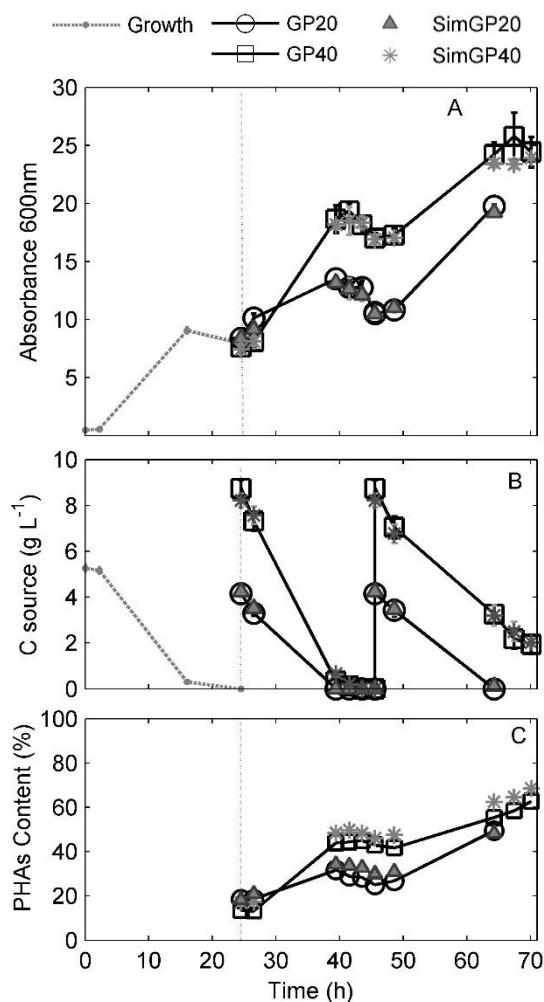

Figure 20: Responses of grown cells to 20% and 40% of GP_{Deph}^{Acid} and $SimGP_{Deph}^{Acid}$ contents in the accumulation media (% v/v). (A) Absorbance (Abs600) values as a function of the time related to growth (---●---) and accumulation phase. (B) Total VFAs consumption profiles. (C) PHAs content (% on a cell dry weight basis) obtained from GC analyses.

The VFAs and PHAs profiles as a function of the experimental time are shown in **Figure 20B** and **C**.

The complete consumption of the carbon sources was detected after 42 hours when GP_{Deph}^{Acid} represented 20% of the accumulation medium (**Figure 20B**). Accordingly, a negative slope for biomass concentration, due to the consumption of accumulated PHAs (**Figure 20C**), started after

3. POLYHYDROXYALKANOATES PRODUCTION FROM GRAPE POMACE

42 h of observation (**Figure 20A**). Similar evidence was observed for the 40% conditions, since VFAs were not detected anymore after 44 hours and absorbance started to decrease two hours later (46 h). Therefore, cells were harvested and re-suspended in fresh media for the application of the second accumulation batch process, which lasted 46 hours in all experimental conditions. The 20% conditions were monitored until VFAs were exhausted, which occurred after a complete experimental time of 64 h (**Figure 20B**). The 40% conditions were stopped after 70 h since no further significant absorbance increase was detected.

At that time, the overall VFAs concentration was 2 g L⁻¹. Final PHAs content, PHAs yields, accumulation rates and final pH values are shown in **Table 9**. PHAs contents, which were measured according to GC analyses, were confirmed by TGA analyses (see ESI Fig. S3⁺).

Table 9: PHAs content (PHAs_{Cont}); PHAs yield (Y_{PHAs/VFAs}); specific accumulation rate (Π_{Accum}); final pH values; obtained when using *GP_{Deph}^{Acid}* and *SimGP_{Deph}^{Acid}* at different contents during the accumulation phase.

	<i>GP_{Deph}^{Acid}</i>		<i>SimGP_{Deph}^{Acid}</i>	
	20%	40%	20%	40%
PHAs _{Cont} (%)	49 ± 1	63 ± 3	48 ± 1	68 ± 1
Y _{PHAs/VFAs} (g PHAs g VFAs ⁻¹)	0.26 ± 0.06	0.25 ± 0.04	0.26 ± 0.06	0.27 ± 0.05
Π _{Accum} (h ⁻¹)	0.0289 ± 0.0014 ^a (0.0372 ± 0.0024) ^b	0.0645 ± 0.0019 ^a (0.0211 ± 0.0032) ^b	0.0295 ± 0.0041 ^a (0.0355 ± 0.0028) ^b	0.0607 ± 0.0035 ^a (0.0204 ± 0.0009) ^b
ΔVFAs (g L ⁻¹)	8.29 ± 0.12	15.53 ± 0.13	8.37 ± 0.11	15.17 ± 0.12
pH _f	7.5 ± 0.1	7.9 ± 0.1	7.5 ± 0.1	8.0 ± 0.1

^a Considering only the real accumulation time; ^b Calculated for the whole second phase duration

The highest PHAs content in cells fed with the actual VFAs-rich effluent (63%) was obtained for the 40% conditions as a consequence of the application of the two consecutive accumulation batch processes. This value represents an encouraging result for the design, set up and evaluation of the bioprocess at the bench-top scale. Moreover, the application of a cell recycling culture system, as demonstrated elsewhere,[19,86] would allow a continuous feeding together with an increase of the final cell concentration.

The comparison among results related to the employment of the actual effluent and the VFAs solution suggests that no inhibition effects due to other organics in *GP_{Deph}^{Acid}* occurred.

Indeed, *GP_{Deph}^{Acid}* tested concentrations were selected in order to avoid VFA inhibition,[46,47] therefore it was important to exclude negative effects due to the effluent matrix. Polyphenols are well known anti-microbial agents. However, they probably did not inhibit the process both because of their low concentration in the *GP_{Deph}^{Acid}* (lower than the inhibitory concentration reported in a previous work[3]) and the fact that their antimicrobial activity is probably not

3. POLYHYDROXYALKANOATES PRODUCTION FROM GRAPE POMACE

significant for this case. This is in accordance with the wine fermentation process in which polyphenols do not cause inhibition.

The polymer production yields were lower than values previously published when pure acids were tested as the carbon source[49,50] ($Y_{PHB/Acetic} = 0.47 \text{ g/g}$ and $Y_{PHB/Butyric} = 0.65 \text{ g/g}$, respectively). However, they were comparable to that obtained when pre-treated olive mill wastewater was employed.[3] Furthermore, they resulted higher yields than reported when the palm oil mill effluent and a pure culture of *Rhodobacter sphaeroides* (0.22 g PHAs per g VFAs)[13] or fermented organic waste and a pure culture of *R. eutropha TF93* (0.16 g PHAs per g VFAs) were used.[52]

The lower calculated Π_{Accum} parameter related to both 20% conditions are concurrent with previous studies,[46,47] reporting higher specific rates in response to higher VFAs concentrations. This evidence was supposed to represent a kind of a mechanism for avoiding the toxic effects due to the acids. On the other hand, the produced polymer was almost pure polyhydroxybutyrate (PHB). It is very well known that pure PHB has limited applicability, since it is highly crystalline and because its melting and degradation temperatures are close to each other.[9,87] A possible perspective to persecute higher industrial interest for the proposed approach can be represented by the addition of a co-substrate such as propionic or valeric acids, these leading to the obtainment of the copolymer poly(hydroxybutyrate-co-hydroxyvalerate), which is more flexible and stronger.[87] Propionic and valeric acids are VFAs that can be easily obtained from other biowastes or by modifying the AAD conditions.[55,88]

To identify whether PHAs were produced only from VFAs or from other compounds occurring in the complex GP_{Deph}^{Acid} matrix, too, initial and final COD values were measured and COD depletions were compared with theoretical calculated COD decays. The measured decreases of COD were $9.7 \pm 2.4 \text{ gCOD L}^{-1}$ and $15.4 \pm 2.6 \text{ gCOD L}^{-1}$ for 20% and 40% conditions, respectively. The calculated theoretical COD decays were $10.20 \pm 0.15 \text{ gCOD L}^{-1}$ and $19.65 \pm 0.20 \text{ gCOD L}^{-1}$, respectively. These results suggested that other organics than VFAs did not significantly contribute to PHAs accumulation.

3.3.3.2 PHAs FROM GP_{Fresh}^{Acid}

Considering the high hexanoic acid content occurring in GP_{Fresh}^{Acid} , it was decided to use *P. putida* since its capability of valorising the C6 organic acid by producing hydroxyhexanoate. Therefore, an experiment was carried out to verify the possibility of producing mcl-PHAs within this alternative substrate.

3. POLYHYDROXYALKANOATES PRODUCTION FROM GRAPE POMACE

Since it was found a literature controversy about if *P. putida* is or not a growth-associated PHAs producer, two strategies were tested: 1- production in two stages and 2-production in one stage

Figure 21.

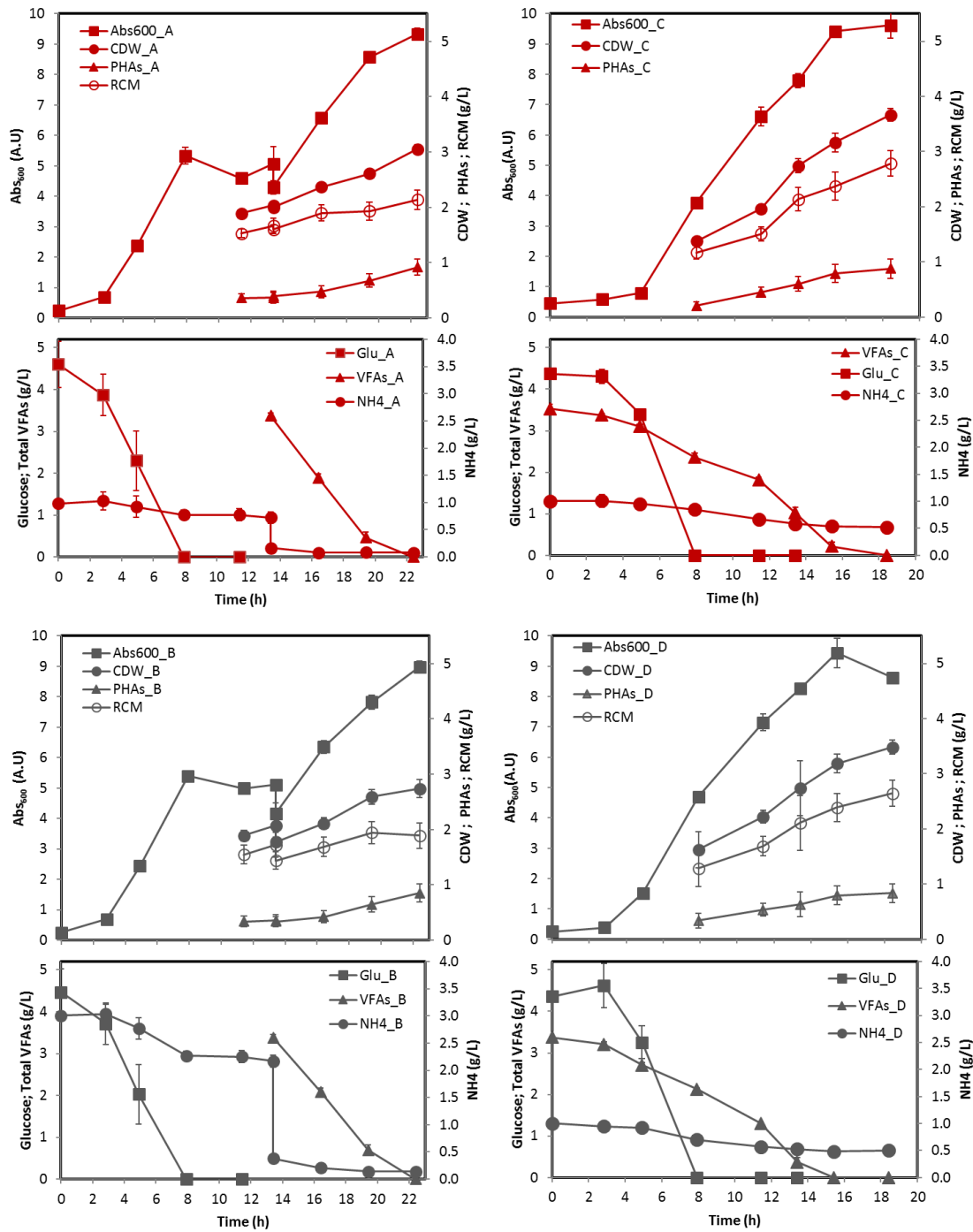

Figure 21: mcl-PHAs production in two stages (A, B) and in one stage (C, D) using *GP^{Acid}_{Fresh}* (red curves) or *Sim_GP^{Acid}_{Fresh}* (red curves). Cell concentration is reported in terms of absorbances (Abs), cell dry weight (CDW) and residual cell material (RCM, non-PHAs material).

3. POLYHYDROXYALKANOATES PRODUCTION FROM GRAPE POMACE

It can be seen that PHAs were produced in both conditions from the VFAs occurring in the GP_{Fresh}^{Acid} . When comparing the results obtained with the real effluent with those obtained with the simulating solution, no significant differences were detected (A vs B and C vs D). Thus, it was inferred that the GP_{Fresh}^{Acid} did not cause any inhibition.

Besides, comparing the different production strategies (A and B vs C and D), a significant lag phase was detected when producing the PHAs in one stage (conditions C and D). This was assigned to the presence of VFAs from the beginning. Regarding the accumulation with or without NH_4 limitation, similar PHAs concentrations were detected (by GC analyses), but the PHAs contents was slightly less in conditions C and D (25% against the 30% obtained in A and B). This was probably due to the fact that (even if hexanoic acid is a PHA related substrate) ammonia was not limiting at all and thus part of the acid could be used for cell growth; in accordance with [89,90].

As previously mentioned, 30% of PHAs content was achieved in conditions A and B. However, a further increase was tested by performing a second accumulation batch (Figure 25). 3.9 ± 0.2 g.L⁻¹ of CDW were obtained, with a PHAs content of 40 ± 4 %. The produced mcl-PHAs were composed by (molar %, from GC-analyses): hydroxyhexanoate (83), hydroxydecanoate (10) and

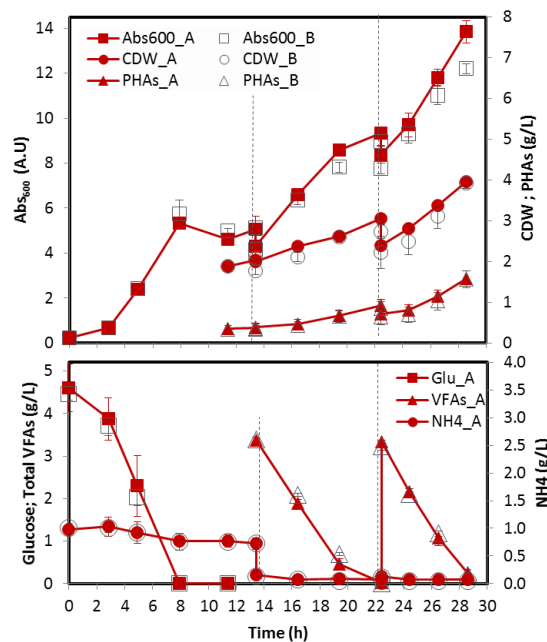

Figure 22: mcl-PHAs production in two stages (A, B) and in one stage (C, D) using GP_{Fresh}^{Acid} (red curves) or $Sim_GP_{Fresh}^{Acid}$ (black curves). Cell concentration is reported in terms of absorbances (Abs), cell dry weight (CDW) and residual cell material (RCM, non-PHAs material).

3. POLYHYDROXYALKANOATES PRODUCTION FROM GRAPE POMACE

the rest by hydroxyoctanoate (-3%) and hydroxydodecanoate (-4%). These values were confirmed by NMR-H and NMR-C analyses (**Figure 26**). Beside these, others characterization were performed by Prof. Annamaria Celli's group; results are shown in **Table 10**.

The PHAs production yield -for condition A, two accumulation batches- was 0.18 ± 0.04 g PHAs . g VFAs⁻¹; similar to those obtained using GP_{Deph}^{Acid} (0.25-0.26) or OMW_{Deph}^{Acid} (0.25).

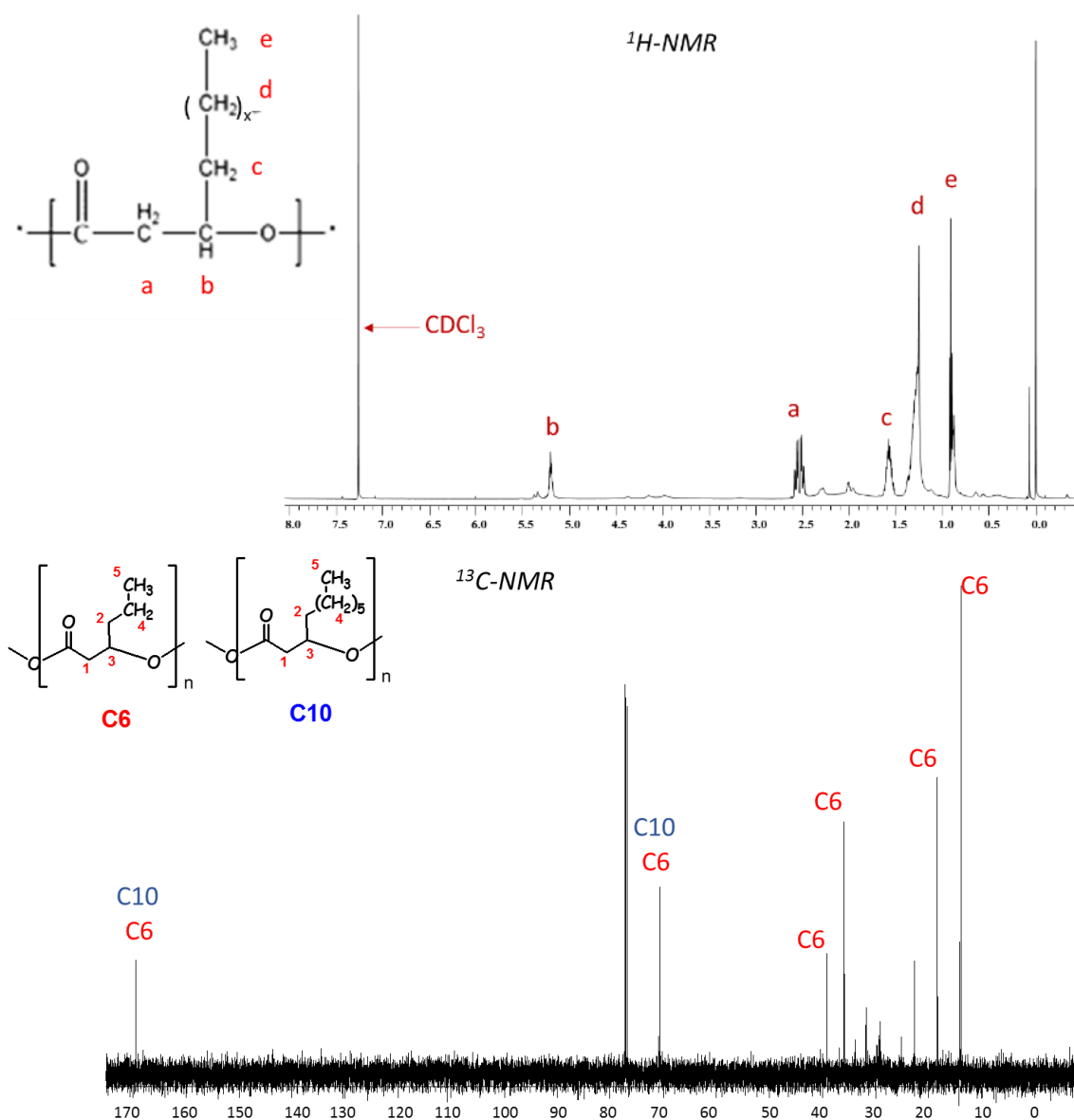

Figure 23: ¹H-NMR and ¹³C-NMR analyses.

Considering all the facts, it can be said that the optimal production process would be one in which a critical cell concentration is achieved using only glucose under balanced conditions (avoiding the growth lag phase). Thereafter, continue working under balanced conditions, VFAs

3. POLYHYDROXYALKANOATES PRODUCTION FROM GRAPE POMACE

feeding starts in conjunction with glucose. In this way, the latter is used only for cell growth (cell multiplication) and the former for PHAs accumulation; this was also observed by [89].

Table 10: Polymer characterization by gel permeation chromatography and differential scanning calorimetry.

Polymer	Mn (kDa)	Mw (kDa)	D	Tg (°C)	Tm (°C)	ΔHm (J/g)	Ref
C6 (80%)-C10 (10%)	94	211	2.2	-33	-	-	This work
C6 (100%)	206	272	1.3	-28	-	-	[91]

3.3.4 BIOGAS PRODUCTION

3.3.4.1 BIOGAS FROM $GP_{Deph;Solid}^{Acid}$

The net cumulative biogas production profiles as a function of the experimental time are presented in **Figure 24**. A rapidly increasing cumulative CH_4 production was observed for about twelve days. After 31 days, 292 mL of biogas were produced. It was composed of methane (67.4%) and carbon dioxide (32.6%), while no hydrogen was detected. At the end of the experiment, 113 mL per g VS of biomethane were obtained.

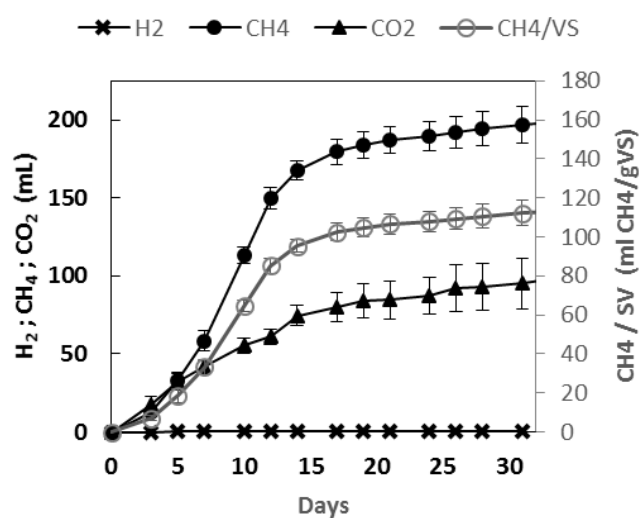

Figure 24: Effective biogas production using GP_{Deph}^{Acid} solid fraction. Accumulated hydrogen, methane and carbon dioxide production trends.

3. POLYHYDROXYALKANOATES PRODUCTION FROM GRAPE POMACE

Such a result did not represent a high biomethanization yield when compared to some evidence obtained with other biowastes.[29] Furthermore, the AD of the same non-pretreated GP at the same inoculum to substrate ratio led to almost double biomethane production (see Section 3.3.4.2). On the other hand, it was quite similar to the value reported by ref. [65] also with non-pretreated GP and a lower inoculum to substrate ratio (0.66). The yields obtained by ref. [66] were significantly higher than those obtained in the present work, but a shredding step was added for oil extraction from seeds. Therefore, the obtained results can be considered of interest in the perspective of developing effective continuous anaerobic methanogenic processes fed with the target leftover and with the potentiality of also including the residues from the PHAs downstream process.

3.3.4.2 BIOGAS FROM $GP_{Fresh;Solid}^{Acid}$

The effective cumulative biogas production trends is shown in **Figure 25**. After 33 days, 465.7 ± 32.4 mL of biogas was produced, composed mainly by (%): CH_4 (68%) and CO_2 (32%); as within the $GP_{Deph;Solid}^{Acid}$ almost no hydrogen was produced. Regarding the yield, 193 ± 10 mL $CH_4 \cdot g VS^{-1}$ were produced; lower than the yield obtained with OMW_{Solid} and higher than the value for $GP_{Deph;Solid}^{Acid}$.

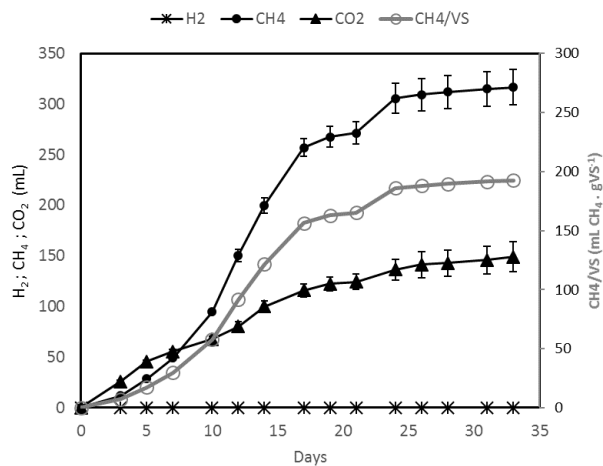

Figure 25: Biomethane production from $GP_{Fresh;Solid}^{Acid}$.

3. POLYHYDROXYALKANOATES PRODUCTION FROM GRAPE POMACE

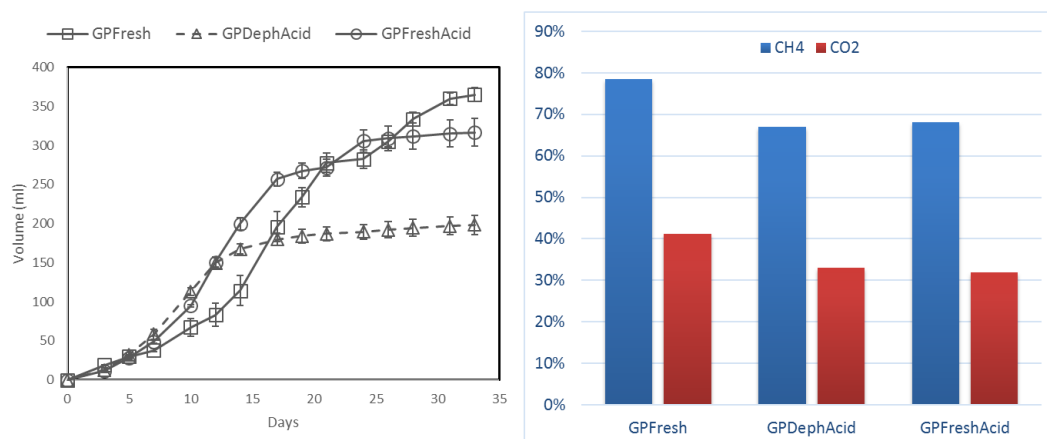

Figure 26: Comparison of biomethane production (right) and biogas compositions (left) for the different AD substrates.

3.4 CONCLUSIONS

In conclusion, the possibility of developing a multi-purpose biorefinery scheme for the valorisation of red grape pomace by obtaining natural antioxidants, volatile fatty acids, biopolymers and biomethane was demonstrated. The extracted polyphenolic fraction included significant amounts of bioactive compounds, which are readily adsorbed by the organisms. The acidification of the dephenolised residue was obtained by feeding the organic matrix to a biological anaerobic acidogenic process. The resulting VFA-rich liquid effluent was employed as the substrate for an effective biotechnological production of PHAs. Biomethane was obtained from the exhausted solid leftover, which was digested under anaerobic methanogenic conditions. To the very best of our knowledge, this study represents the first attempt of exploiting grape pomace for the integrated production of several industrial products. In particular, the target biowaste have never been tested before as an alternative low-cost substrate for the production of PHAs.

4 VFAs RECOVERY AND CONCENTRATION FROM ACIDOGENIC
EFFLUENTS

4.1 INTRODUCTION

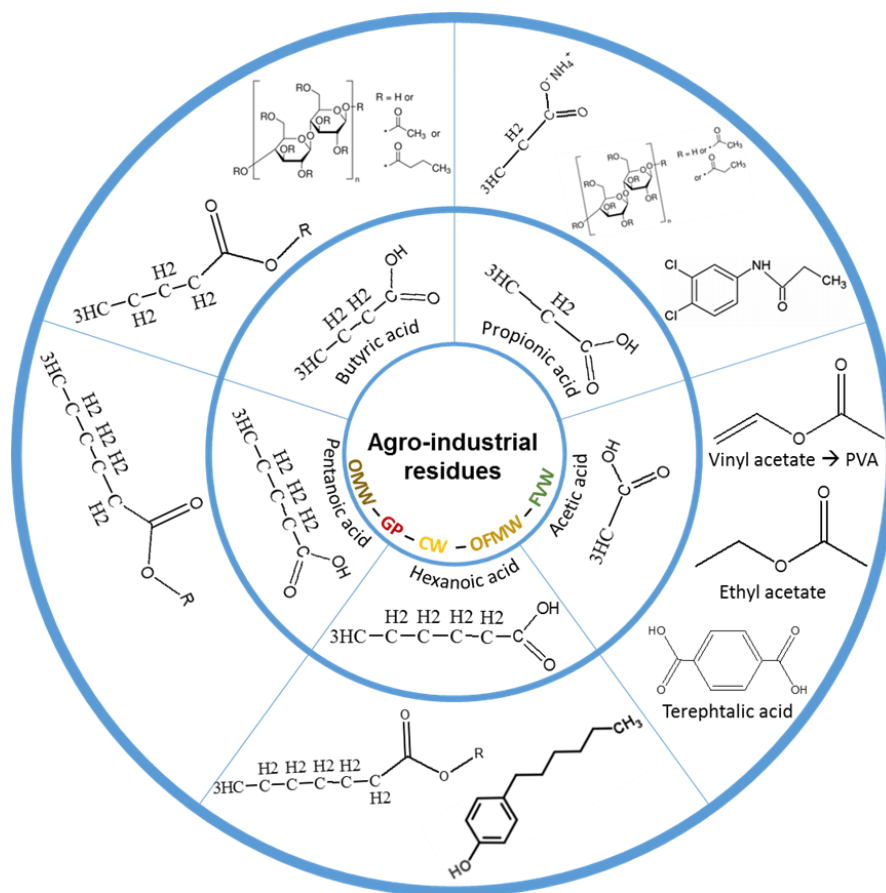

Figure 27: The production of volatile fatty acids (C_2 - C_6) from agro-industrial wastes such as: olive mill wastewater (OMW), grape pomace (GP), cheese whey (CW), organic fraction of municipal waste (OFMW) or fruit & vegetable waste (FVW). Main utilization of the VFAs potentially produced.

In the framework of agro-industrial wastes valorisation, anaerobic acidogenic digestion allows the production of a volatile fatty acids (VFAs) rich effluent from complex matrixes. These carboxylic acids (C_2 - C_6) can be further bioconverted to biogas (CH_4), polyhydroxyalkanoates (PHAs) or exploited as single compounds. This is, their functional group allows to obtain a reduced number of compounds, namely: esters, ketones, aldehydes, alcohols and alkanes. However, the production of many important molecules -including traditional and new products- involves their utilization directly (i.e. reactants) or indirectly (i.e. solvents) as shown in **Figure 27**. Thus VFAs are considered molecules of interest for the chemical industry.

4. VFAs RECOVERY AND CONCENTRATION FROM ACIDOGENIC EFFLUENTS

Therefore, the VFAs separation from the acidified stream is of importance for reaching the feasibility of a “carboxylate platform”. In the case of PHAs production, its importance relies on the fact that

As well, it is very well known the possibility of separating organic acids using polyamide based membranes in nanofiltration (NF). Briefly, this group confer to the membrane a double effect filtration, i.e. due to: 1- porous dimension and 2- charge rejection (NH^+ with COO^-).

From all this, **the main goal of the present work** is to study the separation of VFAs from an acidified effluent by employing a NF process. **The particular aims** were: (A)-to carry out preliminary tests that allow to verify the applicability of NF by employing a laboratory prepared solution that simulates a typical acidified stream (~20 g VFAs /L) and (B)-to study the influence on the rejection (R %) values of the operation transmembrane pressure ($P_t = P_3 - P_2$) at a fixed pH and the pH at a fixed pressure.

Fed-batch or continuous culture systems are employed to avoid inhibition on cells from substrates such as VFAs. As a rule of thumb, an economical feasible polyhydroxyalkanoates process requires a final cell concentration of at least 100g/L, with polymer content higher than 60% (wt PHAs / wt CDW). Considering $Y_{\text{PHAs/VFAs}}$ approximately 0.3-0.4 grams of PHAs per gram of VFAs and a final PHAs content of 80% (80 g PHAs / L), 267 grams of VFAs per liter of culture (20 g cells / L) are required; these to be added stepwise in fed-batch or in continuous. Therefore, in order to minimize the cell dilution effect when feeding, a high concentrated feeding solution is required.

However, a typical acidogenic digestion of agro-industrial wastes allows to obtain 15-25 g VFAs.L⁻¹, that would decrease cell concentration and so render the biopolymer production economically unfeasible.

Therefore, the main goal is to recover and/or concentrate VFAs from fermented broths (anaerobic digestion) in order to obtain a concentrated VFAs solution or more than one if it is also possible to separate them

In this first stage study the particular aim is to concentrate (elimination of water) the VFAs.

VFAs recovery by membrane separation

A briefly compilation (**Table 12**) containing the main process values collected (for reverse osmosis and nanofiltration) from literature is presented.

From all this, concentration seems possible with a polyamide membrane or an aromatic polyamide membrane (better with this last), at pH>7, cut off (100-300), temperature of 25-50°C and pressure between 1-40 bar.

4. VFAs RECOVERY AND CONCENTRATION FROM ACIDOGENIC EFFLUENTS

Regarding a possible future goal, electrodialysis and bipolar membrane electrodialysis (2 chambers) were found to be techniques that do not require any chemical addition. In the last case an acid stream and an alkaline stream are obtained, the second can be used to maintain the pH in the anaerobic reactor. The acids can be finally concentrated by employing the technique previously described.

Real fermented broth and Proposed separation process After anaerobic acidogenic digestion, cells and part of the suspended solids are separated by centrifugation (~10 µm) and the liquid fraction is stocked at 4°C. During the acidogenic fermentation NaOH is added in order to maintain the pH (6-7), in this way all acids are present as sodium salts at the end of the anaerobic process. The main composition of the stream to be treated is presented in **Table 11**, with approximately 80% of the total chemical oxygen demand arising from the VFAs content. The other 20% percent may arise from protein (not determined), phenols (0.5 g/L) and/or lipids (not determined) among others. Hence the concentration of the stream (water elimination) could represent a solution for the biopolymer production.

Table 11: Typical acidogenic effluent composition.

STREAM COMPOSITION		Na salt-Solubility	Acid Solubility
<i>Acetic acid (g/L)</i>	4.1	1230-1300	Miscible
<i>Propionic acid (g/L)</i>	0.3	1000	Miscible
<i>Butyric acid (g/L)</i>	4.2	100	Miscible
<i>Valeric acid (g/L)</i>	1.4	55	49.7 (25°C)
<i>Caproic acid (g/L)</i>	19.4	18-30	10.8 (25°C)
<i>COD from VFAs (g COD / L)</i>	58		
<i>Total Phenols (g/L)</i>	0.5		
<i>Total COD (g COD / L)</i>	70		
<i>pH</i>	7		

4. VFAs RECOVERY AND CONCENTRATION FROM ACIDOGENIC EFFLUENTS

Table 12: Literature review (till 2014) about VFAs separation using NF.

REF	[VFAs] g/L	Membrane	Membrane material	Feed (L/min) [cross flow]	P (bar)	Temp (°C)	pH	R (%)
[92]	0.5	ES10(Nitto Denko)	Aromatic polyamide	0.6 [0.25m/s]	1.25-2.75	25	9	>95
[93]	2-10	Desal-5-DK		4.4 [0.22m/s]	24.5	25	9	90
[94]	-	ES20(Nitto Denko)		1.2	2.9	25	9	99
[95]	10	TLC (Fluid system); NTR759 (Nitto Denko);FT30(Dow)		-	14-28	30	6.8	90-99
[96]	2	Filmtec FT30 Sea Water(Dow)	Aromatic polyamide	5	40	25-30	7-10	>90 100for C6
[97]	1	ESPA2, LFC3 , CPA2 (Hydranautics); BW30 , BW30LE (Filmtec); SG, SE , CE (Osmonics)		6.7	30	25-50	10	>95
[98]		CPA2, ESPA2(Hydranautics); BW30 (Dow)		6.7	5-30	20	6-9	80-99
[99]	1	PCI membranes Systems AFC99 membranes	polyamide	22 [2m/s]	10	20	7-9	>90
[100]	5	Desal-5 DK (GE); AlfaLaval-NF, RO98pHt*, RO99 (AlfaLaval)	*polymeric, 3-layer membrane with an active layer of aromatic PA	8	30	25-40	7-10	90-99

4.2 MATERIAL AND METHODS

4.2.1 CHEMICALS AND STANDARDS

Mineral salts, acids and VFAs standard were purchased at Sigma Aldrich.

4.2.2 EXPERIMENTAL SET-UP

The experiments were carried out in a bench-top scale plant (**Figure 28**) composed by a 10 L-feeding tank, a volumetric pump, a pre-filter (membrane preservation), a membrane testing shield and a pressure regulating valve. The utilized membranes models were DK, AK and AG (General Electric-waters), with a molecular cut-off between 100 and 300 Da. Temperature was controlled at 50°C with an external bath. Once stabilization was achieved for each condition: (1)- the permeate (flux and composition) was evaluated; (2)- also the feeding composition and (3)- pH was controlled with an off-line pH-meter by drop-wise addition of NaOH or HCl (concentrated solutions). VFAs concentrations were determined by GC-FID analysis. First experiments were carried out at different P_t (5-30 bar), at pH 4. A second series of experiments were carried out at different pH (4, 5, 6 and 9) and 15 bar.

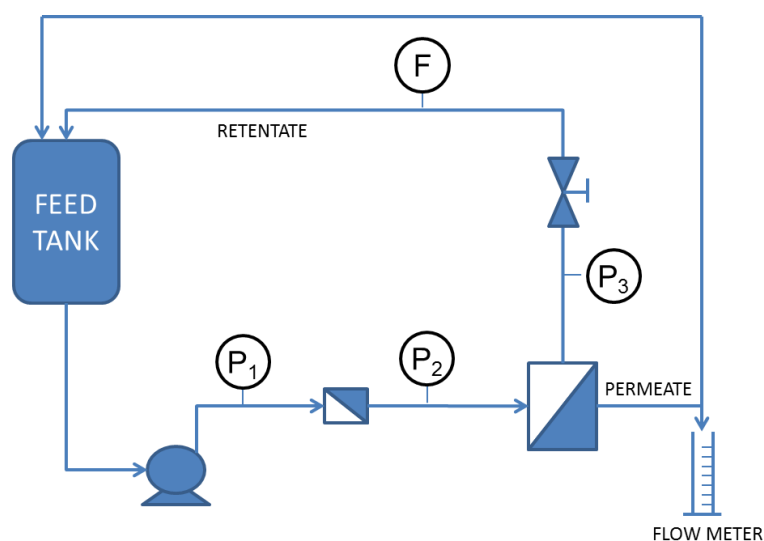

Figure 28: NF bench-top plant.

The stream mentioned represents a special situation since the high hexanoate content; usually C2-C5 VFAs (higher solubility) are produced.

At pH 7 (or higher) acids are retained because of electrostatic repulsion with the negative charged membrane. But hexanoate precipitation might occur if concentrated more

4. VFAs RECOVERY AND CONCENTRATION FROM ACIDOGENIC EFFLUENTS

than 55 g/L. Water can be feed to maintain the hexanoate concentration (dialysis), but this is useless if concentration is pretended.

Therefore a hexanoic acid separation step could be applied, without pH control -hoping that it will develop an acid pH in the retentate- and with a membrane cut off 100Da or less if possible. In this way hexanoic acid would be separated and concentrated in the acid form (no solid formation) because of the molecular size effect. Since the acid solubility is 10g/L, two liquid phases will be formed in the feeding tank: the organic upper phase (mainly hexanoic acid) and the water phase. The membrane separation should continue: the feeding pipe must take liquid from the last phase. Once the hexanoic acid is separated, the rest of the VFAs can be concentrated by filtration at pH>7 since their solubility is higher.

For the real stream, a microfiltration step to separate the suspended solids not decanted by the centrifuge is required. Thereafter, a pre-filtration step could represent a way to eliminate: proteins, phenols and all molecules bigger –in the retentate- than hexanoic acid (MW is 116 g/mol), that will permeate with the rest of the VFAs. The complete flow-sheet would be:

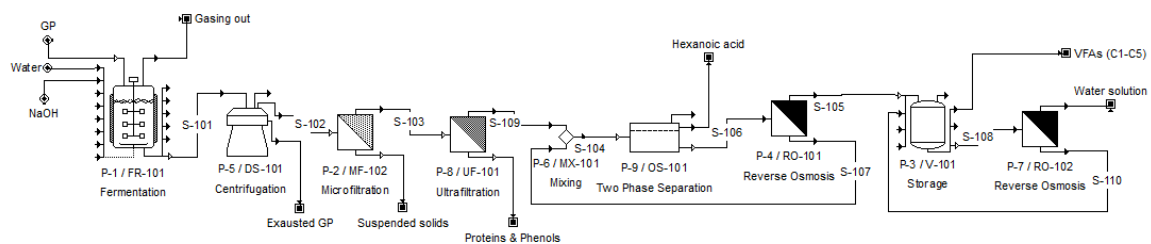

Figure 29: An hypothesised scheme for VFAs separation-concentration, also considering the single separation.

Experimental design

The separation of hexanoic acid (C6) without pH control –only molecular size exclusion effect (MWCO 100 Da)- is proposed to be tested first. Leaving for a second experiment the concentration of the rest of the VFAs by filtration at pH>7 (charge exclusion effect). Or, another option is just trying to concentrate the small VFAs (C2-C5), that are the ones without precipitation problems.

Initially, membranes could be tested by employing a laboratory prepared solution for simulating the VFAs-rich effluent: HK_2PO_4 , 5.8 g/L; H_2KPO_4 , 3.7 g/L and the VFAs; pH between 6 and 7.

As far as known, treatment temperature is not a critical variable for the stream; therefore it is possible to work on the range 20-50°C.

4. VFAs RECOVERY AND CONCENTRATION FROM ACIDOGENIC EFFLUENTS

In which respect to analytical procedures, individual VFAs concentrations can be obtained in 14 minutes with GC analysis. Regarding an online measurement, pH could represent a separation indicator variable.

4.3 RESULTS AND DISCUSSION

The pH parameter affected the R% of both the whole VFA mixture and the single acids more than the operational pressure. Comparing the three tested membranes, the R obtained with AK and AG -for a pH of 9.5- were about 85% and 98%, respectively. In particular, at pH of 4 different R% values were observed for each acid, namely (%): acetic (40), propionic (55), butyric (70), valeric (80) and hexanoic (90) acids. Conversely, the R% related to the DK membrane (20%) suggested that it is not suitable for this application.

The first experiment was dedicated to verify the influence of the operating pressures (5-30bar) at pH 4 and 50°C.

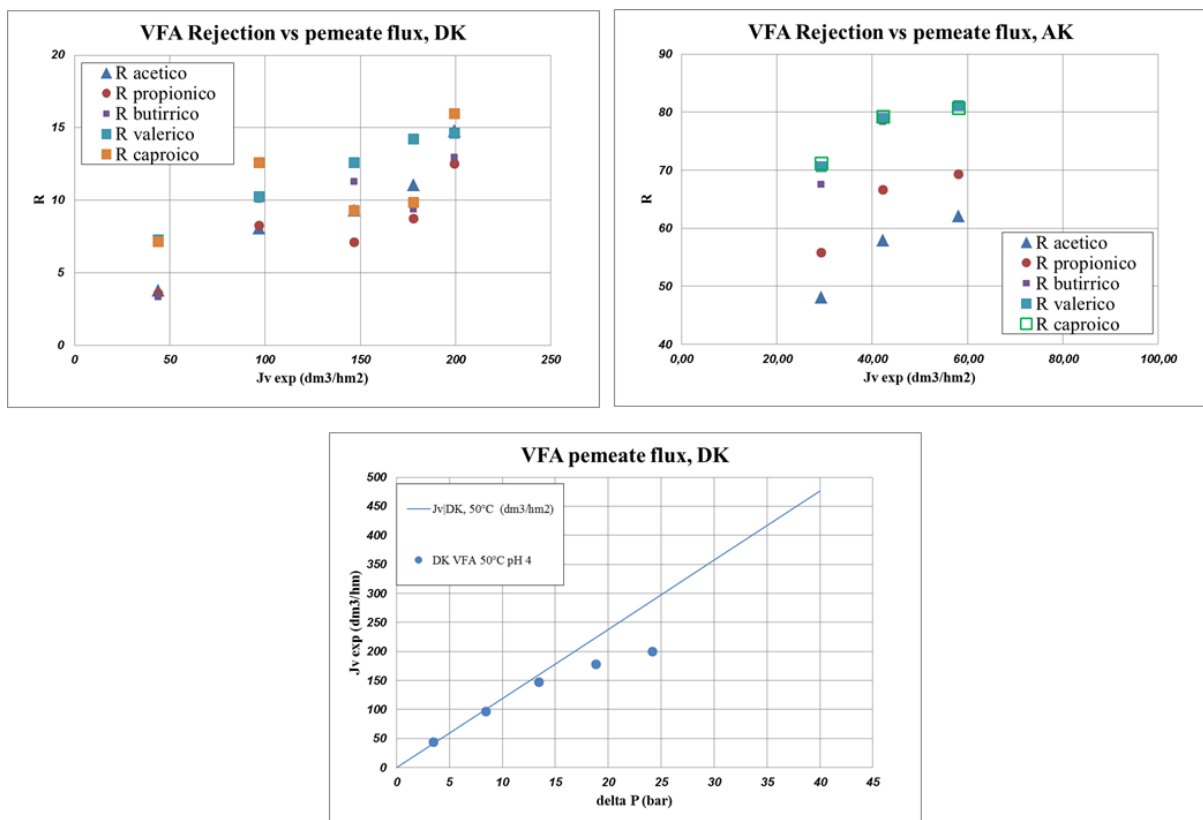

Figure 30: Results obtained at different operating pressures (5-30 bar) at fixed pH and temperature.

4. VFAs RECOVERY AND CONCENTRATION FROM ACIDOGENIC EFFLUENTS

A second experiment was carried out in order to verify the previous results, just with a slightly modification on the pH (3.5 instead of 4). The temperature was the same (50°C) and pressure was the tested variable. Results were not consistently; this was assigned to membranes fouling.

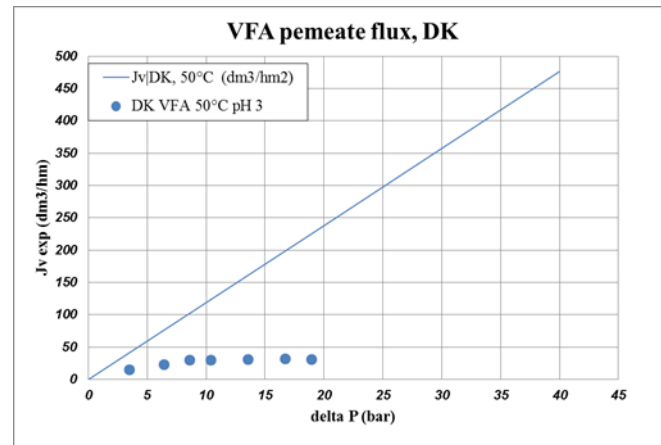

Figure 31: Water permeate test

Thereafter, membranes were cleaned and a blank was done. From this last, it was observed that the membrane DK permeability was two folds the previous measured, while the AK permeability was the original.

A third experiment was carried out, this time the fixed conditions were the temperature (50°C) and the pressure (15bar) and the tested variable was the pH (3.5; 6.5; 9.3).

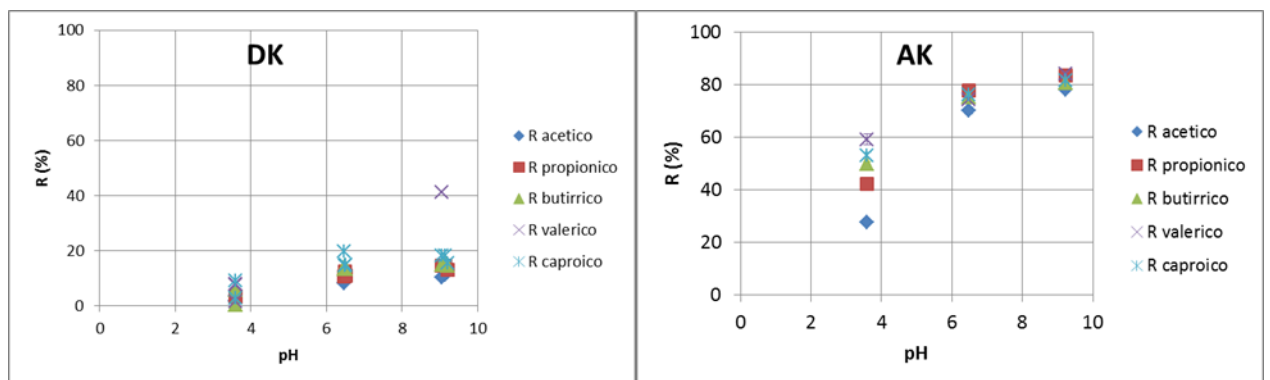

Figure 32: VFAs separation using DK or AK. Rejected values against pH condition.

4.4 CONCLUSIONS

VFAs separation from a *simulated acidified effluent* by NF has been tested and its applicability confirmed. Among tested process variables, pH was observed to greatly influence process performances. This, in combination with the molecular cut-off, would allow to selectively separate the VFAs. A preliminary techno-economic analysis is being carried out for inducing a first input toward the research activities. Besides, more experiments need to be carried out; using different membrane cartridge arrangements for obtaining technical data that would allow a process scale-up and more effective techno-economic analysis.

5 TOTAL PHENOLS DETERMINATION IN OLIVE MILL WASTEWATER BY COLORIMETRIC AND HPLC METHODS

Summary

Valorization of olive mill wastewater (OMW) may include a phenolic compounds recovery. It has already been tested the feasibility of applying solid phase extraction process for the mentioned recovery. Hence, an analytical method need to be applied for the process study. From this, the utilization of a well-known colorimetric method for measuring OMW's total phenols content has been studied, optimized and compared with a HPLC measurements. To this aim, the wastewater matrix effect (interference) was analyzed by performing calibrations in which the solvent for the standards was the dephenolised OMW.

KEYWORDS

Polyphenols content; Olive mill wastewater; Tyrosol, Hydroxytyrosol; Dephenolisation; Modified Lowry method; Phenols determination by HPLC-UV

5.1 INTRODUCTION

Olive mill wastewater (OMW) is a dark brown-greenish effluent -abundant within the Mediterranean region- from the olive oil production. It is very well known that OMW -with high organic matter and phenolic compounds content (see **Table 13**) - has a long term biodegradability. Besides, it is generated in a short period of two months approximately (*seasonality*): from the middle of the autumn till the beginning of the winter. Therefore, it represents a harmful effluent that must be treated before being discharged. Hence, it appears the opportunity of coupling the treatment with the obtainment of added value molecules such as phenolic compounds. These are natural antioxidants, antibacterial, anti-inflammatory and anti-angiogenic activities that can be exploited in the food, pharmaceutical and cosmetic industries [101]. OMW physicochemical and biotechnological treatments coupled with valorization have been studied during the last 10 years, examples are: polyphenols solid phase extraction from the fresh wastewater (OMW_{Fresh}) in a batch process [22]; and from the dephenolised stream (OMW_{Deph}) volatile fatty acids (VFAs) production (OMW_{Acid}) within an anaerobic acidogenic digester [88]. In this last step, complex compounds are bioconverted into VFAs, i.e. simpler and functional molecules that can be utilized for the production of biopolymers [3,11] and/or in the carboxylation platform [68].

Table 13: OMW average physicochemical characterization (Alberto Scoma, 2014)

TS (g.L⁻¹)	64.9 ± 54.3
TSS (g.L⁻¹)	9.8 ± 2.5
VS (g VS.g TS⁻¹)	0.98 ± 0.02
Total Sugars (g.L⁻¹)	17.1 ± 16.0
Oil and Greases (g.L⁻¹)	3.2 ± 2.1
TPhs (g.L⁻¹)	6.8 ± 5.3
COD (g O₂.L⁻¹)	107.1 ± 102.8
BOD5 (g.L⁻¹)	20.4 ± 2.5
pH	4.6 ± 0.4

TS: total solids; TSS: total suspended solids; VS volatile solids; TPhs: total phenols; COD: chemical oxygen demand.

In this line, during the last three years the dephenolisation process of OMW by solid phase extraction has been studied within a bench-top column, simulating a continuous process [27].

5. TOTAL PHENOLS DETERMINATION IN OLIVE MILL WASTEWATER BY COLORIMETRIC AND HPLC METHODS

Specifically, a non-polar resin has been employed as the adsorbent and ethanol is used for the polyphenols desorption step. In these condition, by the moment approximately 75-90% of the polyphenols originally contained in the OMW_{Fresh} are removed. This represents a higher dephenolisation level in comparison with the 60% obtained by the group at the beginning of the study [22].

During this studies, when studying the process optimization or even if a real-scale process would be operated, the determination of total phenols (TPhs) with a fast and accurate method became of high importance for evaluating mass balances and related continuous process performance such as break-through tests.

To do this, the utilization of colorimetric methods would allow performing a measurement in some minutes, by employing a simple procedure which requires small samples volumes and a low cost equipment such as a colorimeter. For the TPhs, the modified Lowry procedure is very well known and its application for wine analysis was described by *Singleton et al.* The disadvantage of all colorimetric methods when determining contents in “real samples” is the high possible interference that may generate the sample’s matrix. In the case of OMW, it known that at least sugars would generate interferences on TPhs determination. [35]

For avoiding interferences and therefore for more accurate determinations, the HPLC analysis could be of interest. This implies the utilization of an instrument that is much more expensive than a colorimeter; this could represent an obstacle when limited economic resources are available. Despite this, HPLC could be considered when more precise TPhs determinations are required or for evaluating how accurate is the colorimetric determination.

From all that mentioned, the main goal of the present work was to study the utilization of the colorimetric method developed by [102] for determining TPhs in: OMW_{Fresh} , OMW_{Deph} and OMW_{Acid} . To this aim, firstly two temperatures were tested for the color-development reaction by comparing the TPhs contents results for real samples. Secondly, the matrix effects (interferences) on the measurements was studied by performing two calibration curves using two different solvents when preparing the standards, namely: (A) water and (B) OMW_{Deph} . Finally, an adsorption test (break-through curve) was performed and TPhs content in the samples were analyzed within the colorimetric method and with HPLC analysis; results were compared by constructing correlation curves. OMWs coming from two different Italian mills were used in this study; both generated during traditional olive oil production (three-phase olive oil extraction).

5.2 MATERIALS AND METHODS

5.2.1 OMWs, chemicals and standards

The OMWs employed in this study were provided by: (i) Sant'Agata d'Oneglia mill (Imperia, Northern-west Italy), generated in 2012 and 2013; and (ii) by Gallipoli mill (Puglia Region in Southern Italy), from 2012 oil production. Both mills apply the three-phase olive oil extraction process. According to the required measurements in the different OMW valorization treatments previously published [22,23,103], different kinds of OMWs were employed: OMW_{Fresh}, OMW_{Deph} and OMW_{Acid}. The formers two are the feeding and exit of the dephenolisation step (see section 5.2.2); and the OMW_{Acid} is the exit stream of an anaerobic acidogenic digester, which consist of a packed bed bioreactor with an HRT of 6-7 days [88] fed with the OMW_{Deph}. TPhs determination in OMW_{Acid} is important (as ultimately control) when the VFAs-rich stream is employed for PHAs production, since they may cause polymer accumulation inhibition (Martinez et al., 2015).

The ethanol (96%), Na₂CO₃, Folin & Ciocalteu's phenol reagent and gallic acid were purchased from Sigma Aldrich. The COD assay test tubes (range: 0-1500 mgO₂/L) were acquired from Aqualytic (Dortmund, Germany).

5.2.2 Dephenolisation in bench-top packed column operating in continuous

The dephenolisation studies were carried out in a glass column (length 525 mm and inner diameter 20 mm), packed with the non-ionic resin XAD 16 (DOW Chemicals Europe GmbH, Switzerland), as described by [27]. Briefly, the pre-treated OMW (without suspended solids) was fed to the column at 2.4 cm/min. Sampling was done every hour from the column bottom and every three hours at the column inlet. These were stock in freezer (-20 °C) for analyses. In this way, OMW_{Deph} was accumulated in a tank and a break-through curve was constructed by analyzing the TPhs content in the samples. For desorption (coupled with regeneration step), acidified ethanol (0.5% v/v HCl 0.1N) was fed from the top of the column. The phenols solution was vacuum distilled in a rotatory evaporator and the ethanol was recovered.

5.2.3 Total phenols determination with colorimetric procedures

The colorimetric method previously developed [35,102] allows to determine total phenols as gallic acid (or other representative standards) equivalent concentration.

Firstly, the colorimetric method at 25 mL-scale have been used [22,88], with color-development reaction at 75 °C. But high standard deviations were obtained. Moreover, a significant number of samples could not be measured as some precipitation and turbidity formed during the test.

5. TOTAL PHENOLS DETERMINATION IN OLIVE MILL WASTEWATER BY COLORIMETRIC AND HPLC METHODS

This negative behavior forced to increase to 5 the determinations for each sample to be sure that at least 3 of them could be measured with a considerable loss in time and materials. In order to diminish the standard deviation and improve the performance of the analysis two procedures were studied and compared: a down-scaled colorimetric procedure and HPLC method (section 5.2.4).

Regarding the down-scaled procedure, this would reduce the amount of reagents to be used. For working with absorbance values between 0 and 1, the procedure described by [35] was slightly modified (μL): H₂O dionex (912), sample (20), Folin & Ciocalteu's phenol reagent (100), mix & wait 1-8 minutes and Na₂CO₃ 20% w/v (300). After 2 hours in dark at ambient temperature (25°C) or at 75°C (when specified), the absorbance was measured at 765 nm using an UV-Vis spectrophotometer Varian Cary 100.

Calibration curves were done initially by preparing gallic acid standards in demineralized water and lately using standards of gallic acid in demineralized water or in OMW_{Deph} (when specified).

5.2.4 Total phenols determination with HPLC

For the chromatographic method, a HPLC-UV/vis (Jasco 875) was employed, with the detector set at 264 nm and within a C18 Kinetex 2.6 μm 100A Phenomenex column. The flow was set at 1.0 mL/min. The following mobile phase gradient was applied: 0-4 minutes, 100% phase A (HPLC water with 0.1 with orthophosphoric acid); 4-6 minutes, 70% phase A and 30% phase B (acetonitrile); 6-15 minutes 70% phase A and 30% phase B. The mobile phase gradient was designed to merge all the phenolic peaks into a single broad peak. This approach makes the analysis faster and the method more sensitive, but it prevents the identification of the single compounds. Gallic acid was added (50 mg/L) as internal standard in each HPLC analysis. Hence, total phenols are determined in gallic acid equivalent concentration but with HPLC.

5.2.5 Chemical oxygen demand (COD)

In order to evaluate how much of the COD -initially present in the OMW- was absorbed by the column, the COD was measured within a commercial colorimetric assay in test tubes and a thermoreactor (ECO16 Velp Scientifica). The absorbance was measured (in the spectrophotometer described in Section 5.2.3) at 610 nm.

5.3 RESULTS AND DISCUSSION

5.3.1 Methods comparison

5. TOTAL PHENOLS DETERMINATION IN OLIVE MILL WASTEWATER BY COLORIMETRIC AND HPLC METHODS

Results obtained when measuring TPhs content in three real fresh samples - different mills and years – are presented in **Table 14**. They were measured using three methods: COLORIM 1 (as in [27]); COLORIM 2 (present work, see section 5.2.3) and by developing a HPLC-UV protocol. The calibration for COLORIM 1 was done with gallic acid in dephenolised water, while for COLORIM 2 standards were prepared in deionized water. Both measurements were done against a blank reaction prepared with deionized water. Results obtained with COLORIM 1 had a greater percent standard deviation than the ones obtained with COLORIM 2, this was attributed to errors in the former procedure: non-repeatability on the final volume (depending precision on volume flask read and not in micropipette) and color development temperature (75°C, faster development and faster disappearance). Moreover, some precipitate occurred for samples analyzed with this method. When comparing ratios of the results between the methods (COLORIM1/COLORIM2, COLORIM1/HPLC and COLORIM2/HPLC), it can be seen that COLORIM2/HPLC is almost constant and are near double of the second for the three samples; interpreted as possible higher correspondence between the methods. The differences in the TPhs could not be due to interferences (i.e. sugars) since samples could not contain the same amount of interfering compounds . But the effect of the colored matrix. Thus, more studies on the down-scaled colorimetric method were carried out.

Table 14: Comparison of TPhs values, standard deviation (STD) and percent standard deviation (%STD) obtained with three methods: COLORIM 1 (performed at 25mL and 75°C (REF)), COLORIM 2 (performed at 1.3mL and 25°C) and HPLC_UV.

	COLORIM 1			COLORIM 2			HPLC_UV			Col1/ col2	Col1/ HPLC	Col2/ HPLC
	TPhs		STD	TPhs		STD	TPhs		STD			
	(mg/L)	±	%	(mg/L)	±	%	(mg/L)	±	%			
Puglia 2012	4140	513	14	5279	433	7	2787	245	9	0.78	1.49	1.90
Imperia 2012	1964	216	11	2013	23	1	1071	97	9	0.98	1.83	1.88
Imperia 2013				942	15	2	507	19	4			1.86

Note: values presented are the media and standard deviation of: 5-7 analyses for COLORIM 1, 3 analyses for COLORIM 2 and 2 analyses for HPLC

5.3.2 Colour development reaction for the down-scaled method: 25°C or 75°C

The first test was dedicated to determine the better temperature for color development, using the down-scaled procedure. Hence, five real samples (Imperia 2012, 2013, dephenolised and

5. TOTAL PHENOLS DETERMINATION IN OLIVE MILL WASTEWATER BY COLORIMETRIC AND HPLC METHODS

fresh and Puglia 2012 fresh) were analyzed by applying the down-scaled procedure at 75°C and 25°C (2 hour for both). Deionized water was used for diluting samples (when needed for measuring absorbance's values between 0 and 1) and for preparing the blank. Results are shown in **Figure 33**. A correlation between both conditions was found. It can be seen that the standard deviation for the condition 75°C are much bigger. This was attributed to the fact that at higher temperature color develops faster, thus color extinction occurs sooner (Singleton et al., 1999) and finally less sensibility may be achieved. Indeed, lower absorbance values were obtained for the 75°C condition.

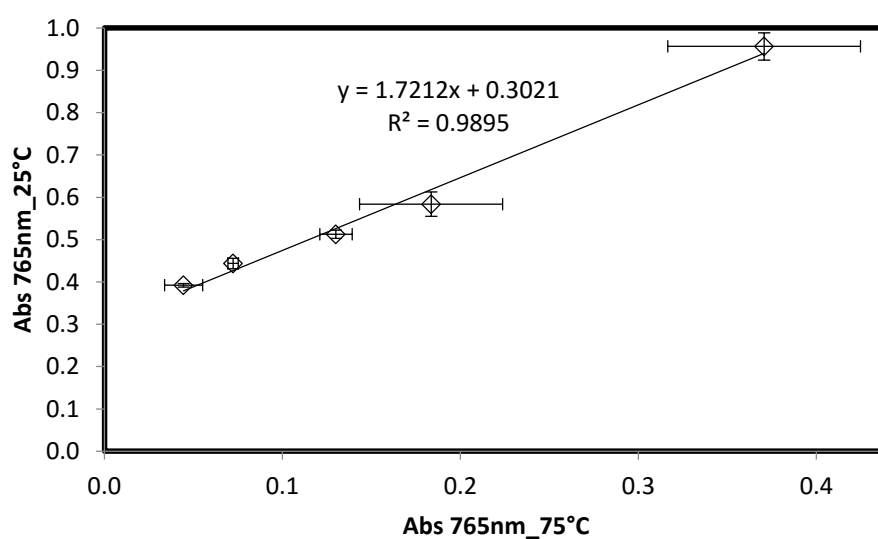

Figure 33: Correlation curve for absorbances obtained -with the down-scaled procedure- by performing the color development at 75°C and at 25°C. Each point represent the average value of three analyses and standard deviation is represented by the error bars.

5.3.3 Matrix interference analysis

For evaluating the matrix interferences in the colorimetric method, which concentrations are almost double the concentrations determined by HPLC, two calibration curves were performed using: (i) OMW_{Deph} and (ii) deionized water as solvent (for preparing the standards with gallic acid) and as samples when making the color-development reaction for preparing the blanks. Three different standards were prepared for each concentration in order to analyze also the repeatability of the procedure. First the standards were measured in the spectrophotometer against the blank prepared with deionized water and thereafter the same standards were measured against the blank prepared with OMW_{Deph} (See **Figure 34**). When converting the

5. TOTAL PHENOLS DETERMINATION IN OLIVE MILL WASTEWATER BY COLORIMETRIC AND HPLC METHODS

intercept obtained from the linear fitting of the calibration against blank prepared with water (0.33897) into TPhs content it came out that TPhs in the OMW_{Deph} was about 216.5 mg/L . Indeed, the same value was obtained from determining the TPhs using a calibration curve performed entirely using dionex water as solvent.

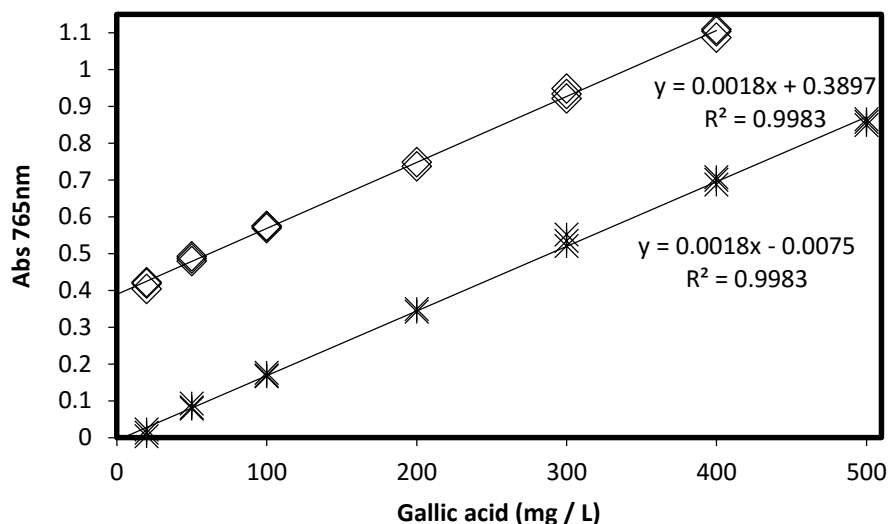

Figure 34: Calibration curves using OMW_{Deph} as solvent for preparing the standards and dionex water (\diamond) or OMW_{Deph} ($*$) when making the reaction for preparing the blank.

5.3.4 Phenolic compounds determination with the down-scaled colorimetric and the HPLC methods: correlation between methods

The obtained break-through curves with the colorimetric and HPLC analyses are presented in **Figure 35**. As it can be seen, a front of COD started to exit from the column before TPhs or at least faster; this is more evident when analyzing the derivatives of the curves.

5. TOTAL PHENOLS DETERMINATION IN OLIVE MILL WASTEWATER BY COLORIMETRIC AND HPLC METHODS

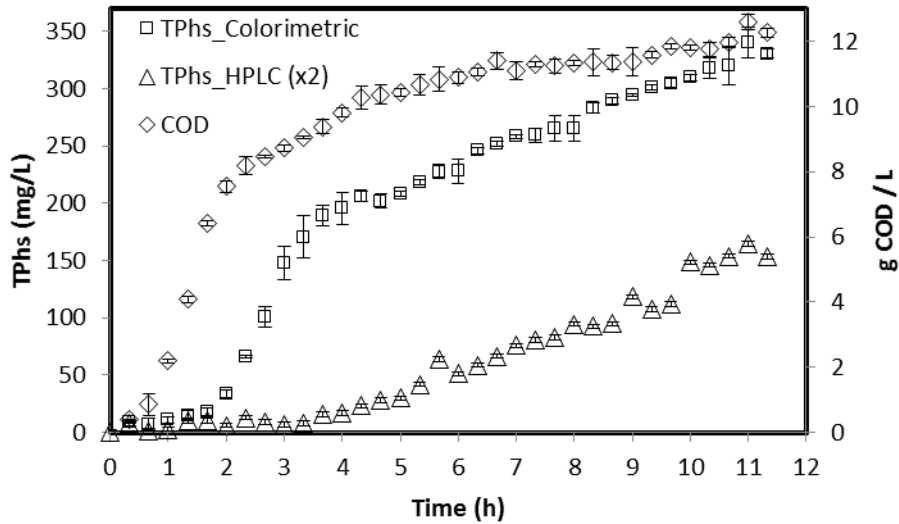

Figure 35: Dephenolisation break-through test. TPHs content in the samples taken from the exit stream of the column and analyzed by colorimetric and HPLC methods (real values were multiplied by 2). Also COD was analyzed. The presented values are the mean of three measurements and standard deviation is represented by error bars. For the HPLC, single analyses values are presented and the standard deviation was calculated from the calibration.

When analyzing correspondence between both methods (**Figure 36**), it was found that there was no correlation during the first part of the dephenolisation (till 3.33 hours) and from that time both methods showed a high correlation ($R^2 > 0.96$). The obtained slope for this linear fitting indicated a proportional relation of 2; which is in accordance with the proportion found it in **Table 14**.

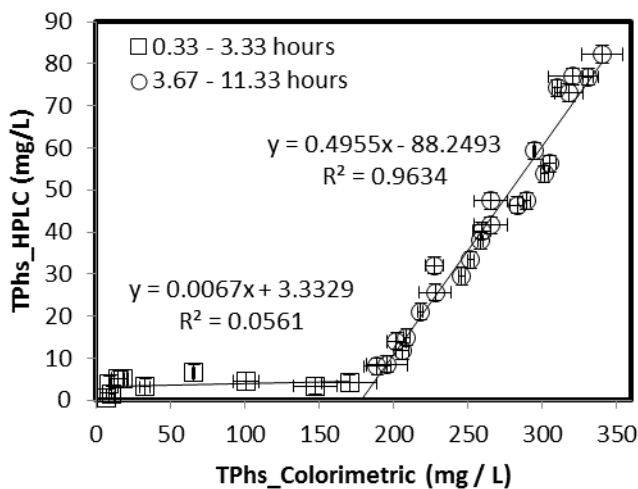

Figure 36: Correlation analysis. TPHs determined by HPLC-UV vs TPHs determined by the colorimetric method.

5. TOTAL PHENOLS DETERMINATION IN OLIVE MILL WASTEWATER BY COLORIMETRIC AND HPLC METHODS

Therefore, firstly it was hypothesized that the colorimetric 2 measurements were interfered by some molecules: initially absorbed by the resin, which rapidly was saturated and so the exponential increase of the total phenols value. As mentioned previously, typical interference with the colorimetric methods are related with sugars and proteins among others, their effects are based on their relative concentration ($[\text{protein}]/[\text{phenols}]$ and $[\text{sugars}]/[\text{phenols}]$). However, the hypothesis of interference on the colorimetric method is in doubt, since the correspondence between both analytical methods started when the sigmoidal curve obtained for the colorimetric analysis was on the late exponential –meaning that all those points were corresponded already- and so maybe the applied HPLC-UV analysis is not accurately determining phenols (e.g. the ones attached to proteins) during the first part (0-3.33 hours); where no meaningful trend was detected.

When evaluating correspondence between COD and TPhs_HPLC, high correlation was found between 4.33 and 11.33 hours (**Figure 37**). This was assigned to the fact that after some time the column is saturated in phenols, then the linear increase detected as COD is due to the phenols that are not retained any more.

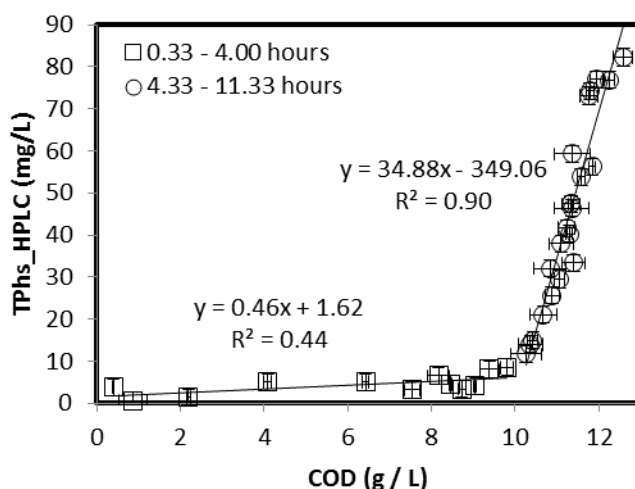

Figure 37: Correlation analysis between TPhs determined by HPLC-UV and COD.

Furthermore, the correlation between TPhs_colorimetric and COD arisen two correspondences (**Figure 38**): from 0.33 to 1.67 hours and from 2 to 11.33 hours. Thus, it seems that other compounds -apart from phenols- are being detected with the TPhs colorimetric method. But this would be in contradiction with the almost perfect correlation found between HPLC and the colorimetric methods.

5. TOTAL PHENOLS DETERMINATION IN OLIVE MILL WASTEWATER BY COLORIMETRIC AND HPLC METHODS

When analyzing the first correlation in **Figure 38** (0.33-1.67 hours), it can be seen that while COD varied 15 times, TPhs_Colorimetric varied almost 2 times. This was assigned to the fact that some polyphenols were not retained and therefore measured as COD, however most of the COD was due to others compounds rather phenols.

Regarding the second correlation in **Figure 38** (2.00-11.33 hours), three out of seven points of the range 33.35-195.75 mg/L (2.00 – 4.00 hours) are out of the line (even considering the error bars) and thus correlation was not considered for that part of the range. Therefore, it exist correspondence between TPhs_colorimetric and COD almost for the same range of **Figure 37** (TPhs_HPLC vs COD) and **Figure 36** (TPhs_HPLC vs TPhs_Colorimetric), which is the range in which the column is already saturated and so COD increased only because phenols were not retained anymore. Moreover, from all that mentioned and considering the fact that no correlation between TPhs_colorimetric and the others procedure for the range 0.33-3.67, it can be hypothesized that TPhs_COLORIMETRIC could affectively be measuring total phenols also during the range 0.33-3.67 hours (**Figure 35**). Indeed, the obtained curve with the colorimetric procedure seems to be a theoretical one, while it is not possible to say the same about the TPhs_HPLC curve.

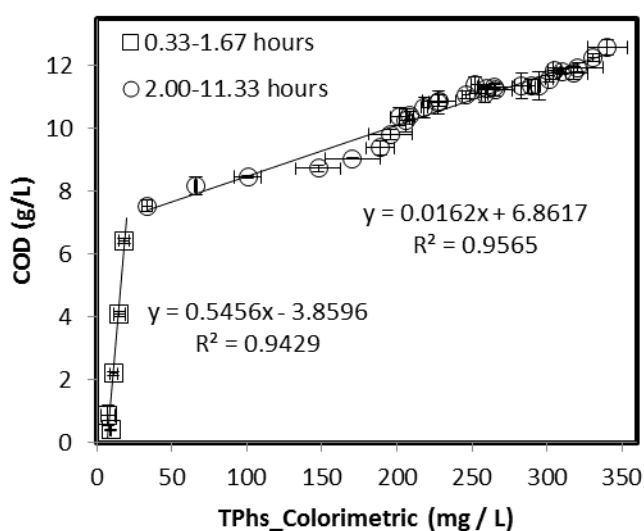

Figure 38: Correlation analysis between COD and TPhs determined by colorimetric method.

5.4 CONCLUSION

The implementation of a colorimetric method for determining TPhs in OMW was studied and verified. This is important when working with trial tests at lab-scale, where usually low amount

5. TOTAL PHENOLS DETERMINATION IN OLIVE MILL WASTEWATER BY COLORIMETRIC AND HPLC METHODS

of samples volume (~1-5 mL) are available. Besides, this method would only requires the utilization of a colorimeter, i.e. a relative cheap and easy to use technical equipment. This last is also an advantage for analyses performed at industrial scale.

In order to achieve total verification, one more comparison is required. This is, the implementation of the sample pre-treatment procedure described by the official analytical methods for wastewater, in which phenols are separated by distillation from all possible interferences and therefore it can be analyzed by colorimetric technique.

Acknowledgements

This work was supported by the European Commission in the frame of the EU Project FP7-KBBE-2012-6–single stage ID. 311933 “Water4Crops” - contract no. 311933

Specials thanks to Eng. Rebecchi S., who collaborates initially for setting up the HPLC method.

6 RECOVERY AND PURIFICATION OF POLYHYDROXYALKANOATES

Summary Polyhydroxyalkanoates (PHAs) production costs are mainly associated to carbon sources and to the down-stream process. This work is focused on optimizing the downstream by lowering its cost, but maintaining the biopolyesters special characteristics.

In this framework, the goal of the present work was to evaluate different NaOH digestion protocols -in combination- for the recovery and purification of PHAs from *Cupriavidus necator* DSM-545 strain. In particular, the study was addressed to evaluate the effect of the following parameters: centrifugation speed, biomass concentration, NaOH concentration, digestion temperature, agitation during the digestion step and the application of an acidic pre-treatment and ethanol washing post-digestion. The whole procedure consisted on the following steps: cell digestion in a NaOH solution; centrifugation for three washing steps (with distilled water, ethanol solution and distilled water again) and drying. Thereafter, results were analysed in terms of purification degrees and recovery yields.

Tested NaOH extraction procedures allowed high purification degrees. The highest value (almost 96%) was obtained by applying the sulphuric acid pre-treatment, with biomass and NaOH concentrations of 50 g/L and 0.1 N, respectively, at 30°C. Generally, no significant differences in the purification degree were observed when centrifuging at different rates, in the presence or absence of agitation during the digestion process and at different tested temperatures. However, higher polymer recovery yields were obtained at centrifugation speed ≥ 10000 rpm and without any agitation. Importantly, process effectiveness was not negatively affected by increasing the cell concentration up to 100 g_{DM}/L.

KEYWORDS

PHAs; Recovery; Purification, TGA; Molecular weight; NaOH digestion

6.1 INTRODUCTION

Nowadays the development of alternative polymers production processes is of great interest, either when looking for a new property or a more eco-compatible material. In this framework, polyhydroxyalkanoates (PHAs) are considered an interesting biopolymers family, since they can be produced from renewable resources at the same time they exert similar or even better physicochemical properties than those of petrochemical-based polymers (e.g. polyolefin). PHAs are aliphatic polyesters, which are produced and stored by several bacteria as a carbon and energy source; usually when cell growth is limited by the lack of some nutrients. These polymers are totally biodegradable by bacteria. Therefore, PHAs are potential substituters of petrol based polymers. [6–9]

However, it is not easy to achieve an economic feasible process. Main costs of the PHAs production are those due to the carbon source for the fermentation process (usually sugars) and to the downstream process (biopolymer separation and purification), each accounting to 40-60 % of the total cost [2,87]. Thus, alternative strategies to lower the production cost have been studied in the last years. Most of the work have been focused on the up-stream improvement by applying different alternative cheap carbon substrates when employing pure or mixed cultures [3]. On the other hand, the development of down-stream processes have been also studied during the las years; trying to achieve an effective (high purity and recovery), sustainable and cheap process. However, it is considered that it remains to be studied the protocols -in combination- with the particular strains.

From all this, the goal of the present work was to evaluate NaOH digestion, ethanol and acid pretreatment protocols for the recovery and purification of PHAs from *Cupriavidus necator* DSM-545 strain.

6.2 MATERIAL AND METHODS

6.2.1 CHEMICALS AND STANDARDS

The salts (BioReagent) for the mineral medium, glucose (BioReagent), ethanol and other reagents were purchased from Sigma–Aldrich.

6.2.2 PHAs PRODUCTION AT BENCH-TOP BIOREACTOR

Cupriavidus necator (DSMS 545) inoculum was started from LB-Agar plates and grown within 24 hours in 500 mL Erlenmeyer flask containing 150 mL of LB medium; incubation conditions were 30°C and 150RPM.

6. RECOVERY AND PURIFICATION OF POLYHYDROXYALKANOATES

Polyhydroxybutyrate (4 carbons PHAs, PHB) production was carried out in 3 L Bioreactor (BIOSTAT B, Sartorius) in two stages fed-batch: 1- growing cells in a balanced mineral medium and 2- polymer production in the same medium but ammonia free (accumulation trigger). The feeding solution was sterilized glucose.

At the end of the fermentation the broth was thermal treated (80°C for 15 min), cells were harvested by centrifugation (8000 rpm, 6°C, 25 min), washed and stocked at 4°C till used.

6.2.3 PHAs RECOVERY AND PURIFICATION TESTS

NaOH digestion experiments were carried out in 100 mL shake-flaks (30mL working volume), with a magnetic stirring bar, under controlled temperature. Different conditions were tested, namely: digestion time, biomass concentrations (10,20,50,100,150,200 g/L), centrifugation speed to recover the PHAs after NaOH digestion (5000, 10000 or 15000 rpm), NaOH concentration (0.05 or 0.1 N); digestion temperature (4 or 30°C) ; agitation during the digestion step (0,100 or 750 rpm); application of an acidic pre-treatment (by using 0.1N sulphuric, acetic or lactic acid, at a temperature of 80 or 30 °C for 2 h or 15 min).

The PHAs purity (P) is defined as the PHAs content in a total dried biomass. While the recovery yield (R) is the ratio between the amount of PHAs after the downstream procedure and the amount of PHAs at the beginning, therefore:

$$R = \frac{CDW \times Purity}{CFW \times \left(\frac{CDW}{CFW}\right) \times C_{0,PHA}}$$

6.2.4 ANALYTICAL PROCEDURES

Sampling was performed periodically. The optical density (OD) measurement at 600nm, using a Cary-100 UV-Vis spectrophotometer, was implemented to detect cellular concentration variations. Cellular concentration, in terms of cell dry weight (CDW), can be determined by employing an OD vs. CDW calibration curve (data not shown). Thereafter, samples were centrifuged; the supernatant and pellet were separated and stocked for analyses. Fructose was determined by HPLC-IR analysis, using a Varian Hi-Plex H column (300 x 7.7 mm); the mobile phase was sulphuric acid 5 mM at an elution rate of 0.6 mL/min and the operating temperature was 65°C.

PHAs content –and so purity- was measured by thermogravimetric analysis (TGA 4000 Perkin Elmer). The temperature program started at 100°C with a ramp of 10°C/min till 400°C; and N₂ flux at 40mL/min.

6.3 RESULTS AND DISCUSSION

6.3.1 PHAs production in bioreactor

The production concentration trends are presented in **Figure 39**. After 71 hours the biomass concentration was approximately 60 g/L; with a PHAs content of about 80%.

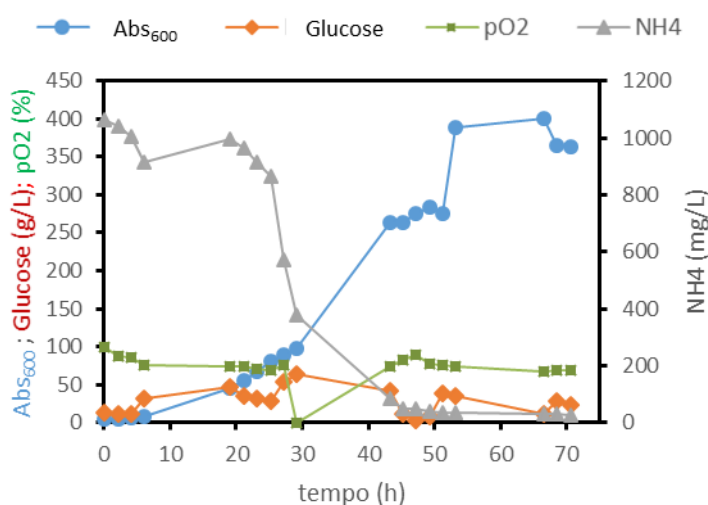

Figure 39: PHAs production. Concentration trends during the fed-batch fermentation.

After heat treatment, cells were recovered by centrifuge and washed. The dry weight of the biomass pellet was determined to be 43.9 ± 0.5 % (g CDW / g FW).

6.3.2 PHAs recovery and purification tests

6.3.2.1 Required digestion time

The first experiment was dedicated to define the required NaOH 0.1N digestion time. From **Figure 40** it can be seen that after 1 hour the purity arrives to a plateau at 84%.

6. RECOVERY AND PURIFICATION OF POLYHYDROXYALKANOATES

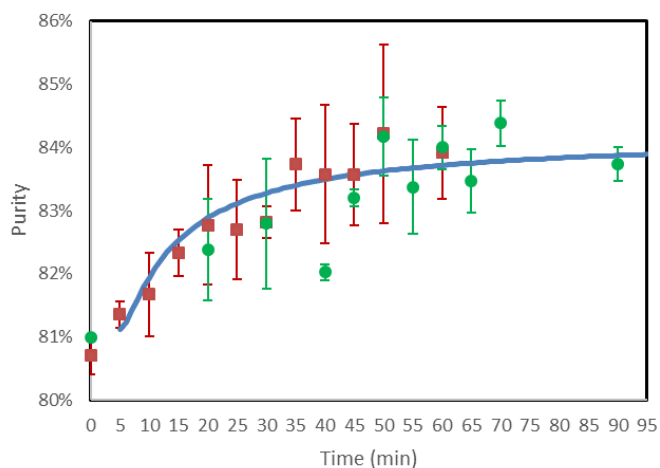

Figure 40: Required digestion time of non-PHAs biomass digestion with NaOH 0.1N at 30°C, measured as PHAs purity in the remaining pellet.

6.3.2.2 Influence of temperature and agitation

A second experiment was dedicated to study the influence of the temperature and the agitation during the digestion with NaOH. The obtained results are shown in **Table 15**.

Table 15: NaOH digestion, influence of temperature and stirring

Biomass concentration	NaOH solution	Digestion temperature	Agitation rate	Purification degree	Recovery yield
(g/l)	(N)	(°C)	(rpm)	(w/w _{DM})	(w/w _{DM})
20	0,1	30	750	89,23 ± 0,089	86,19 ± 5,224
			NO	89,85 ± 0,787	89,96 ± 6,584
		4	750	86,27 ± 0,023	n.d.
			NO	86,44 ± 0,026	n.d.

6.3.2.3 Biomass concentration optimization

A third experiment was dedicated to find the high-limit of biomass concentration to be treated with 0.1N NaOH. The obtained results are shown in **Table 16**.

Table 16: NaOH digestion, maximum biomass concentration

Biomass concentration	NaOH solution	Digestion temperature	Agitation rate	Purification degree	Recovery yield
(g/l)	(N)	(°C)	(rpm)	(w/w _{DM})	(w/w _{DM})
10	0,1	30	100	89,19 ± 0,001	90,80 ± 0,351
20				89,23 ± 0,089	86,19 ± 5,224
50				88,42 ± 1,020	88,07 ± 1,250
100				88,49 ± 0,077	88,77 ± 1,247
150				86,54 ± 0,379	87,37 ± 0,774
200				85,84 ± 1,240	86,87 ± 0,056

6.3.2.4 NaOH concentration optimization

Table 17:

Biomass concentration (g/l)	NaOH solution (N)	Digestion temperature (°C)	Agitation rate (rpm)	Purification degree (w/w _{DM})	Recovery yield (w/w _{DM})
50	0,1	30	100	88,42 ± 0,010	88,07 ± 0,013
	0,05			92,08 ± 0,006	85,14 ± 0,001

6.3.2.5 Ethanol washing: required time

Once optimized the digestion time, the ethanol washing protocol was applied and evaluated, results are shown in Figure 41. It can be seen that after 1.5 hours the purity arrives to a plateau at 89%.

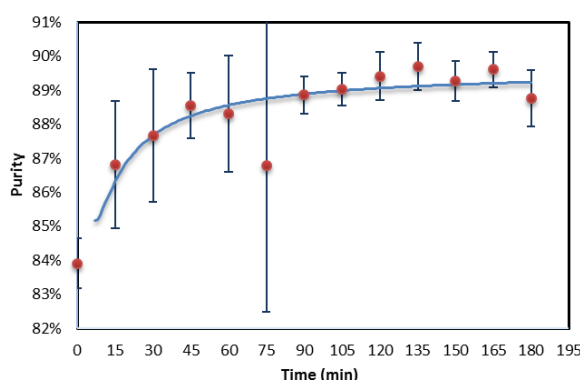
**Figure 41:** Post-treatment: washing with ethanol 20% v/v

6.3.2.6 Pre-treatment implementation

The implementation of an acidic pre-treatment was proposed as to achieve higher purity values and to protect the PHAs granule from NaOH degradation. The obtained results using sulphuric (pK_a 1.99), lactic (pK_a 3.86) or acetic acid (pK_a 4.76) are shown in **Figure 42**. It can be seen that the pre-treatment with sulphuric acid allowed to obtain more than 95% of PHAs purity, and recovering 84% of the initial PHAs. This last, the recovery yield lower than for the standard procedure, do not showed the effectiveness on PHAs degradation. However, to analyse this it is necessary to determine the molecular weight; which could be a more relevant and evident variable.

6. RECOVERY AND PURIFICATION OF POLYHYDROXYALKANOATES

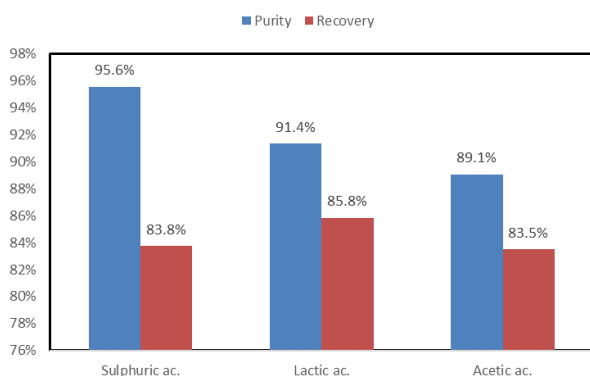

Figure 42: Pre-treatment with acids 0.1N at 80°C for 2 hours, followed by digestion with NaOH and washing even with ethanol.

The future work will be focus on analysing the same treatment variables but using the GC-analysis to determine PHAs. Regarding the acid pre-treatment, formic acid (pK_a 3.77) could be tested for replacing sulfuric acid, as it could probably represent a future cheap acid (from the levulinic acid production). Besides, time treatment and concentration must be optimized for this step.

6.4 CONCLUSIONS

An internal procedure was developed for studying the water based PHAs separation and purification. Specifically, for the non-PHAs digestion using NaOH.

From these test:

- no significant differences in the purification degree were observed when centrifuging at different rates. Higher polymer recoveries were obtained at speed ≥ 10000 rpm
- Low temperature did not favour the purification degree
- Process effectiveness was not negatively affected by increasing the cell concentration up to 100 g_{DM}/L
- The agitation rate during the alkaline digestion did not significantly affect the purification degree. Higher polymer recoveries were obtained without any agitation
- The application of acidic pre-treatments enhanced the purification degree significantly when using sulfuric acid (P > 95%).

7 GENERAL CONCLUSION AND FUTURE WORK

7.1 GENERAL CONCLUSIONS

In this thesis the production of polyhydroxyalkanoates from pretreated agro-industrial wastes was studied. Specifically, olive mill wastewater and grape pomace were used. The obtained results will contribute in the near future to design more proper experiments at bench-bioreactor towards the production cost evaluation.

Regarding the olive mill wastewater employment, different tests allow to identified polyphenols as the accumulation inhibition responsible and to accumulate PHAs without using any extra carbon source.

In which respect to the employment of grape pomace, phenols present in it did not exerted any negative effect. This is important when considering the implementation of a fed-batch system culture using the alternative carbon source. Besides, it was possible to obtain a higher volatile fatty acids concentrated stream, what allowed to obtain higher cells and PHAs concentration. Moreover, it was also possible to produce a different mix of organic acids -rich in hexanoic acid instead of acetic acid- by changing the biorefinery scheme. This last allowed to produced medium chain length PHAs with high hydroxyhexanoate content from an alternative-cheap carbon source, using a wild type strain.

From the PHAs production studies, the concentration of the VFAs mixture was detected as crucial for developing biorefinery schemes. The preliminary study on concentration using membrane separation process allowed to demonstrate the feasibility of working with acidic effluent containing around 20 g/L, which is a higher concentration than what found in literature. This verification may impact on the feasibility of developing a carboxylate platform through the valorisation of many agro-industrial wastes that can be digested under acidogenic conditions.

The validation study of the analytical colorimetric method for determining total phenols would impact not only in future lab-research studies but also in hypothetical OMW industrial treatment. This is by evaluating a process performance with an easy and cheap technique that requires only the reagents and a colorimeter.

The preliminary study on the water based biopolymers recovery and purification allowed to tests all together the implementation of a procedure including acid pretreatment, the digestion using NaOH and washing with ethanol; for the well-known strain *Cupriavidus necator*.

7.2 FUTURE WORK

Considering the work developed and the obtained results, the following suggestions for future work are proposed:

For the PHAs production using olive mill wastewater, since the polyphenols content would influence on the accumulation rate, it would be necessary to establish a kinetic model so as to simulate and study the performance -feasibility and costs- of different culture systems, e.g.: cell accumulation with cell recycling.

Now regarding both alternative substrates, bioreactor tests must be carried out in order to validate the obtained results. To this aim, it is necessary to concentrate the acids if considering a fed-batch process. Thus, studies on acids separation using a pilot scale nanofiltration plant will be carried out. Specifically, for testing different cartridge arrangements and for verifying operational conditions; all this as to design a reliable process that allows to evaluate the techno-economic feasibility of the concentration step.

As for the colorimetric method for total phenols determination, it would be useful to implement a sample pre-treatment procedure for separating the phenols and thus avoiding any potential interference on the colorimetric measurement. Thereafter, direct comparison between colorimetric measurements will allow to determine the accuracy of the actual procedure.

Finally, the biopolymer downstream performance relies also in the molecular weight of the obtained polymer. A GPC column was recently acquired to analyse this property. Thus, future work on this subject will be focused on comparing the different water based strategies considering also this variable.

All that mentioned, techno-economic feasibility studies must be performed using process simulation. Even using partial results, this study would allow to detect processes or procedures that should be optimised in order to render possible a such pretended biorefinery. To this aim, a licence software was acquired and simulation studies started.

8 APPENDICES

8.1 POLYHYDROXYALKANOATES QUANTIFICATION BY GAS-CHROMATOGRAPHY ANALYSIS: *PROCEDURE SET-UP*

8.1.1 Methanolysis treatment time

Aims:

- 1- To determine the necessary treatment time to get maximum HBMet concentration and so to be able to perform the calibration.
- 2- To detect unidentified picks on the chromatogram, that increase and decrease their area during the methanolysis treatment. These may be some methanolysis intermediate compound.
- 3- To test if the methylated monomer (HB-Me) is starting degradation at a certain time. This is important in case a produced polymer (medium or long chain length) needs a long treatment time to be methylated, which could introduce error to the short chain length polymer determination.
- 4- To test if the benzoic acid is methylated or not. And, if it was methylated, to test the ester degradation during time.

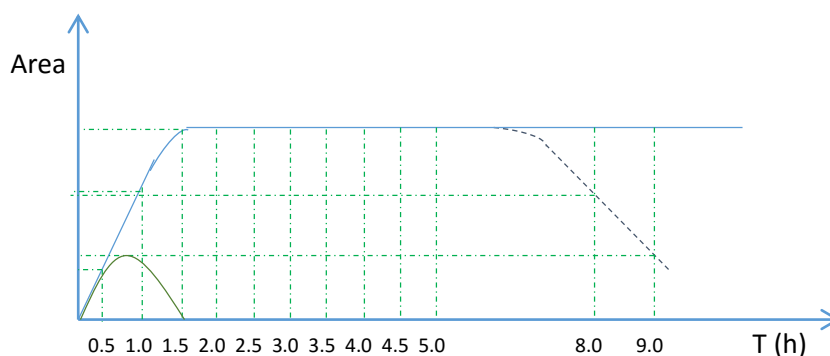
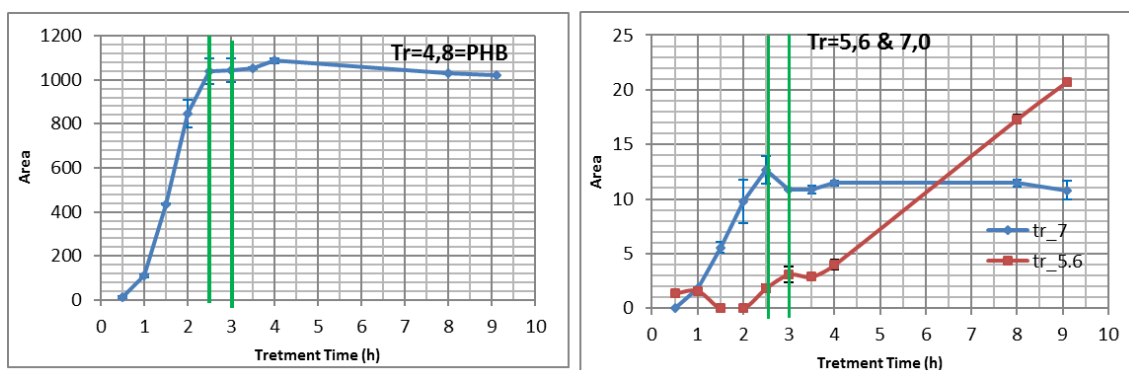
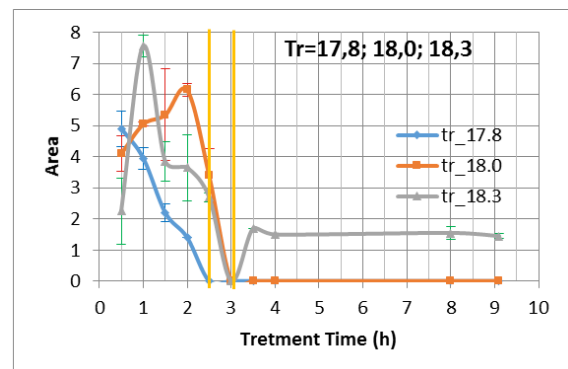
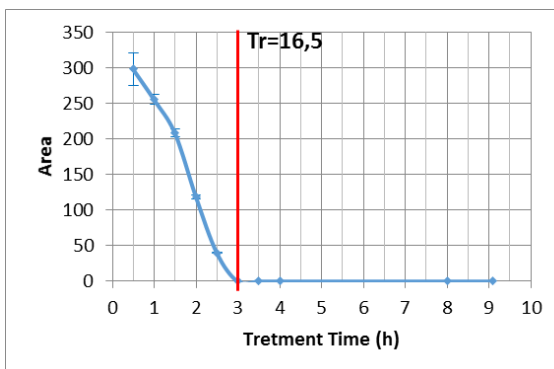
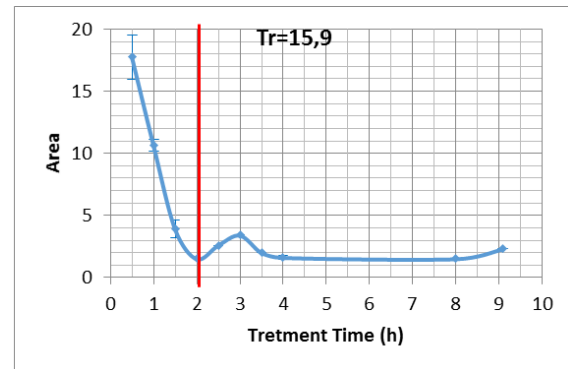
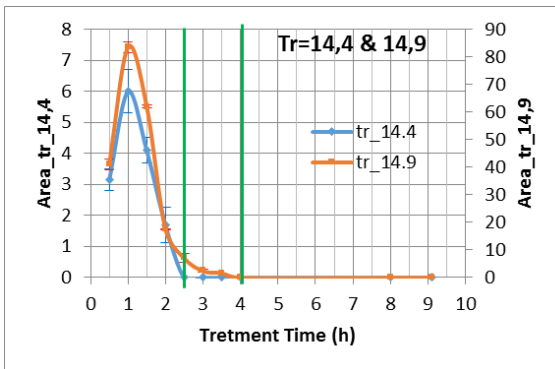
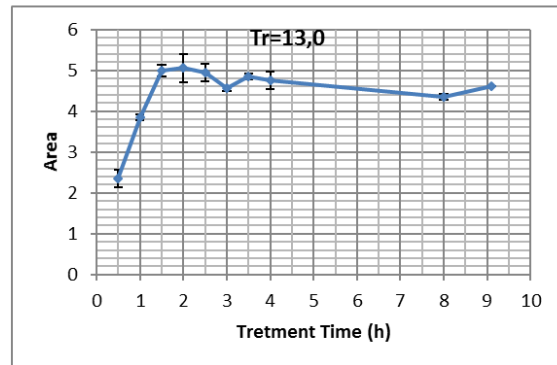
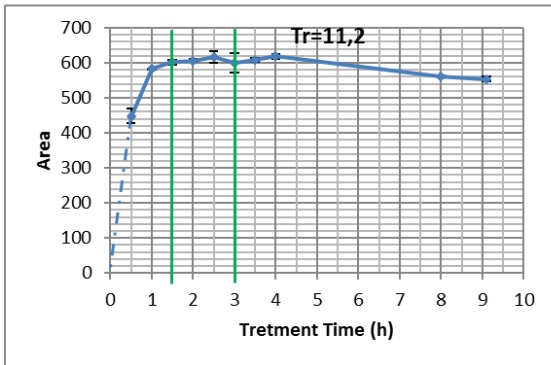
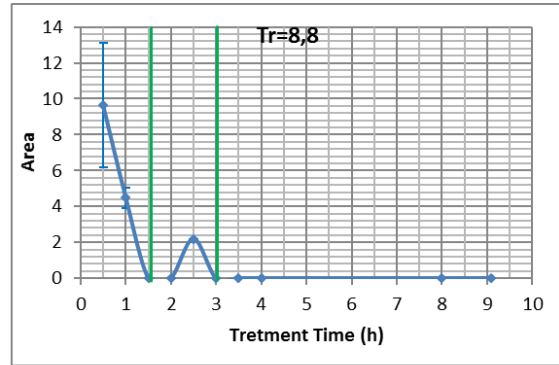
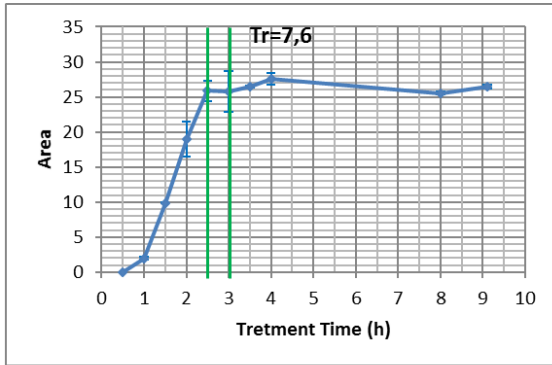
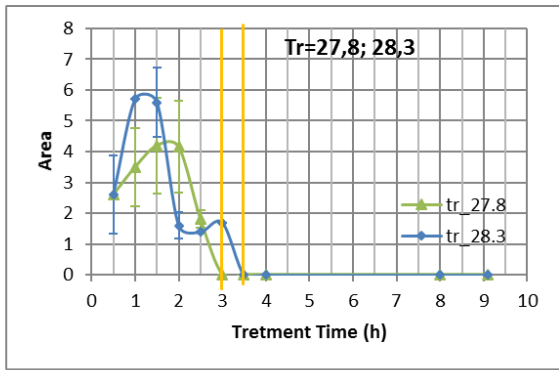
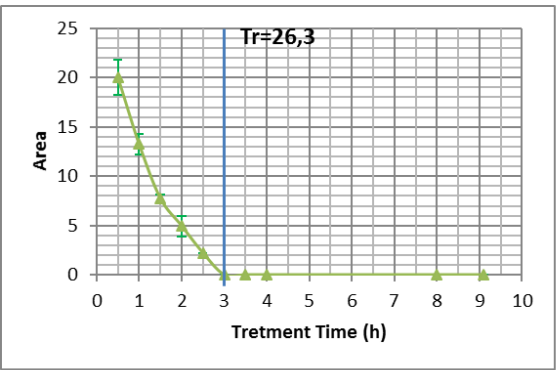
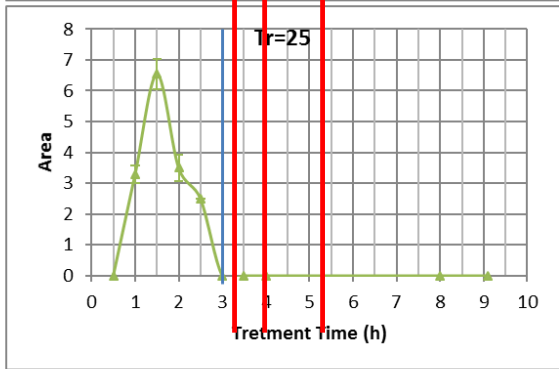
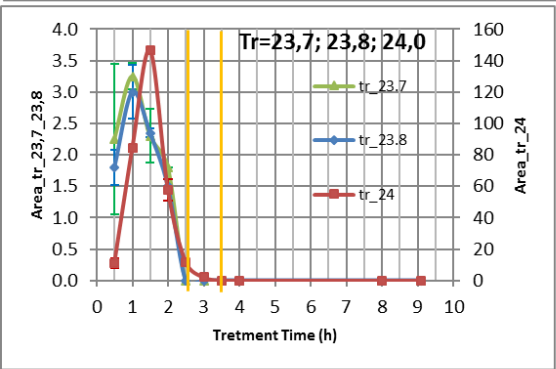
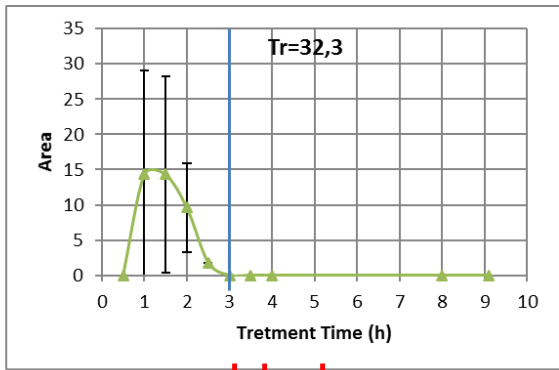
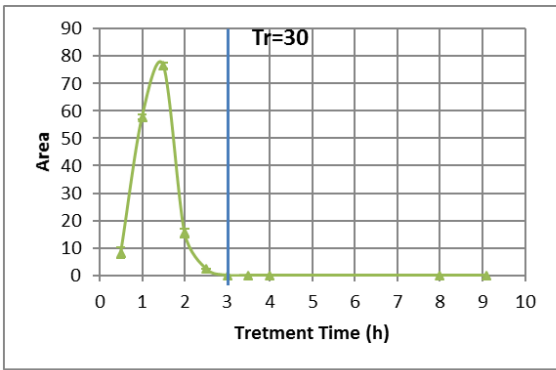
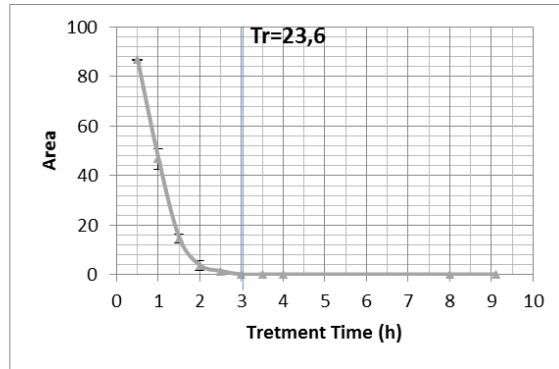
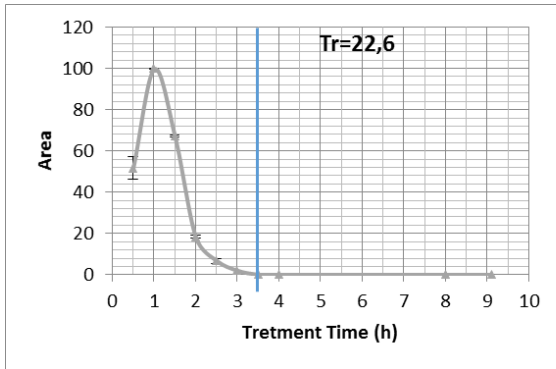

Figure S1: Increasing area of a pick with a determined retention time versus treatment time

The obtained experimental data are showing the following figures, in which it was represented the pick area for each retention time against the treatment time.







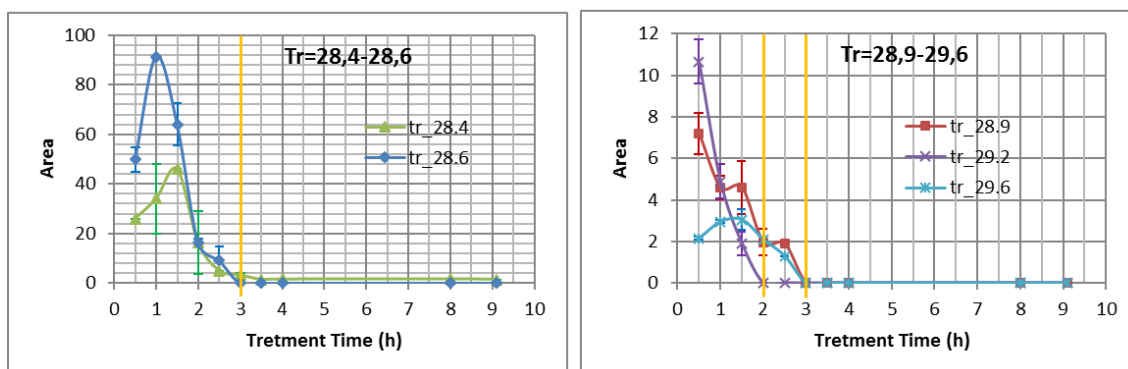

Conclusion and observations:

From the graph tendency for the pick area at 4.8min the necessary methanolysis treatment time for the standard polyhydroxybutyrate, for these conditions, is between 2.5 and 3 hours.

Benzoic acid methyl ester ($t_r = 11.2\text{min}$) is methanolysed faster than PHB, it was completely methanolysed after 1.5-2 hours. This could be because the PHB first has to be first hydrolysed and then methanolysed. Moreover, the amount of HB monomer moles is higher than the benzoic acid (0.8mg/ml). The benzoic acid methyl ester was identified previously (the first methanolysis with the Pirex tubes) by performing a methanolysis of a blank samples, which means the reaction solutions without PHAs and treated in the same way.

Jan et al found that when a treatment time of less than 3.5hours two picks where seen at the chromatograms: 14.4min and 21.9min. In this case there were found more than two picks that where indicating intermediates components existence: see the graphs that show a decrease or increase-decrease tendency. Moreover, maybe the ones that show only decrease belong to the monomer and the ones that show increase followed by a decrease belong to intermediates components (reactants for the methanolysis, reaction mechanism).

It is thought that there are present other types of monomer; not only hydroxybutyrate methyl ester ($t_r = 4.8\text{min}$) but also at 7; 7.6 and 13min at least. The necessary treatment time for these is the same (3 hours).

It seems that at 32,3min another intermediate component was detected; the graph tendency indicates this (appearance and disappear). The high standard deviation is because every four analysis a column wash have been performed.

The standard PHB contains 2-hydroxyisobutyric acid, a low amount. There was an increase of the area value along time of the pick at 3.2min. In a previous methanolysis experiment 2-

hydroxyisobutyric acid has been used to see if its pick ejects near the HB-Me pick, and so it was observed a retention time of 3.2min.

Maybe, by relating the speed of increase and decrease of the picks area value and the extinction time, it can be establish the correspondence between picks; and therefore for the methylated monomers.

Samples weight and concentration description:

METHANOLYSIS TREATMENT TIME				
Campioni	PHB (mg)	[PHB] (mg/ml)	t (h)	11:47
1	10,0	5,00	0,5	12:17
2	10,1	5,05		
3	10,0	5,00	1	12:47
4	10,0	5,00		
5	10,1	5,05	1,5	14:17
6	10,1	5,05		
7	10,1	5,05	2	14:47
8	10,1	5,05		
9	10,2	5,10	2,5	15:17
10	10,0	5,00		
11	10,1	5,05	3	15:47
12	10,1	5,05		
13	10,0	5,00	3,5	16:17
14	10,0	5,00		
15	10,0	5,00	4	16:47
16	10,0	5,00		
17	10,0	5,00	8	19:47
18	10,0	5,00		
19	10,1	5,05	9,1	20:55
20	10,0	5,00		

Cultivated *Ralstonia eutropha*

AIMS:

- 1- To determine the necessary treatment time to get maximum HBMet concentration and so to be able to detect it.
- 2- To detect unidentified picks on the chromatogram, that increase and decrease them area during the methanolysis treatment. These may be some methanolysis intermediate compound.

- 3- To test if the methylated monomer (HB-Me) is starting degradation at a certain time. This is important in case a produced polymer (medium or long chain length) needs a long treatment time to be methylated, which could introduce error to the short chain length polymer determination.
- 4- To test if the benzoic acid is methylated or not. And, if it was methylated, to test the ester degradation during time.
- 5- To detect others monomers: medium or long length chain monomer that with a short treatment time maybe they are not detected.

CONDITIONS:

Temperature treatment and GC column and program are all the same the treatment time analysis of standard PHB.

<i>R eutropha</i> METHANOLYSIS TREATMENT TIME				
Campioni	PHB (mg)	[PHB] (mg/ml)	t (h)	08:30
1	9,9	4,95	0,5	09:00
2	10,3	5,15		
3	10,3	5,15	1	09:30
4	10,3	5,15		
5	10,2	5,10	1,5	10:00
6	10,2	5,10		
7	10,4	5,20	2	10:30
8	10,3	5,15		
9	10,6	5,30	2,5	11:00
10	10,4	5,20		
11	10,3	5,15	3	11:30
12	10,4	5,20		
13	10,1	5,05	3,5	12:00
14	10,4	5,20		
15	10,4	5,20	4	12:30
16	10,3	5,15		
17	10,3	5,15	5	13:30
18	9,9	4,95		
19	10,4	5,20	8	16:30
20	10,3	5,15		
21	10,2	5,10	12	20:30
22	10,4	5,20		
23	10,4	5,20	0	14:30
24	10,3	5,15		

EXPERIMENT

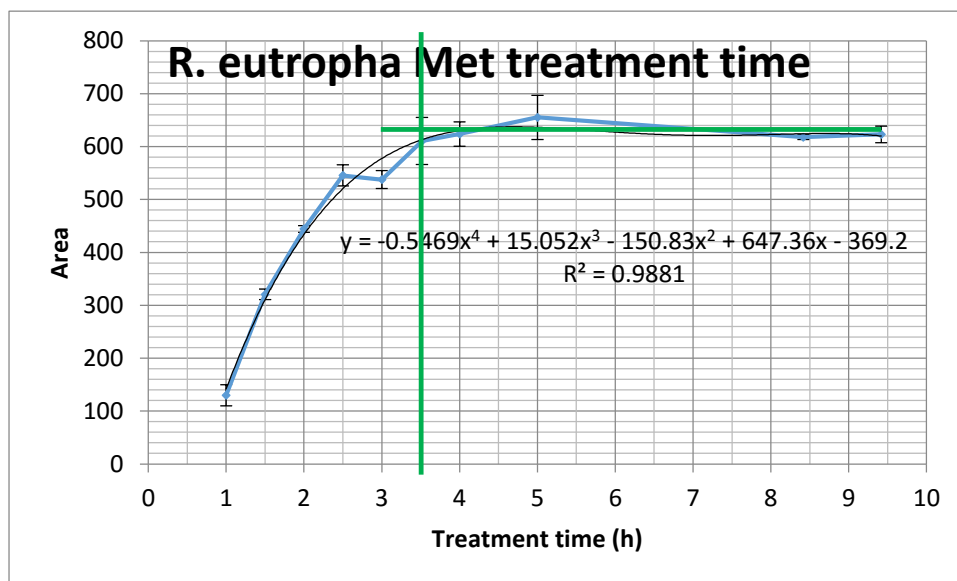

CHROMATOGRAPHS THAT SHOW THE REDUCE OF THE PICKS AREAS DURING TIME (INTERMEDIATES)

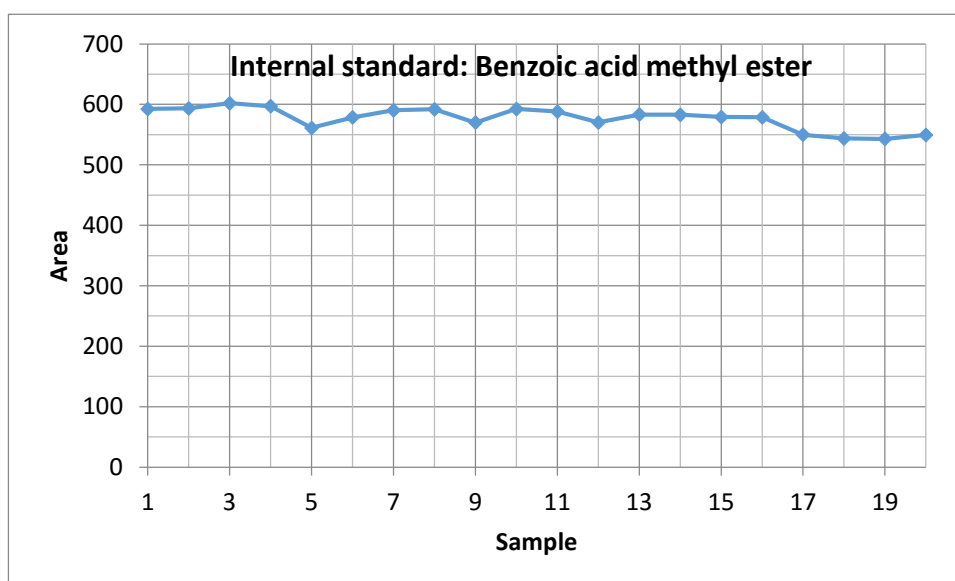
**Conclusions and observations**

The treatment time needed for *R. eutropha* ATCC 17697 is 3.5 hours approximately; which is the same result obtained by Braunegg for *R. eutropha*. But to get sure all the HB is methylated, and then a 4 hours treatment will be implemented.

For studying the HV and others hydroxyacids methylation kinetics, after performing the calibration using the HB, HV, hydroxydecanoic acid and others methyl esters standards from

Sigma Aldrich the obtained chromatographs of this experiment have to be revised and analysed in which respect to the dynamic of the pick area at the corresponded retention time.

Even though it has been used a 10%H₂SO₄ methanol solution the treatment time was not reduced as the experiments from Lavagen and Jan insinuates. The amount of treated biomass maybe has a strong influence on this.

In which respect to the internal standard graph, it shows that the value of the f factor is between 550 and 600.

8.1.2 Methanolysis-GC Calibration

AIMS:

- 1- To get a correlation between pick area and PHB concentration
- 2- To test the range of linearity of the determination technique

CALIBRATION USING A STANDARD POLYMER (PHB)

- 3- *Option 1:* Weight the corresponded amount of polymer in each tube. Do not prepare a unique solution (PHA + chloroform) for trying dissolving it at different concentrations and finally perform the methanolysis. The PHAs are hard to dissolve in chloroform (at least at ambient temperature), and heating the chloroform is not a comfortable step to add to the procedure. Therefore, if the calibration has to be done by diluting concentrated solution and preparing one by one, the found solution is *option 2*.

CONDITIONS

The samples were treated for 3hours at 100°C. The methanolysis solutions were the same composition as previously. The GC program is the short one, called PROVA5BENGSON.

EXPERIMENT

[PHB] (mg/ml)	[PHB] (mg/ml)	Area	Area _{average}	STD	%STD
0,3	0,30	47	55,35	11,24	20%
	0,30	63			
0,6	0,60	80	77,45	4,17	5%
	0,60	75			
0,9	0,90	161	162,20	2,26	1%
	0,90	164			
1,2	1,20	203	209,05	8,98	4%
	1,20	215			
3	3,00	545	550,22	8,09	1%
	3,05	565			
4	4,00	771	773,80	3,96	1%
	4,00	777			
6	6,00	1107	1100,90	8,91	1%
	6,00	1095			
10	10,05	1881	1943,52	101,93	5%
	10,00	2016			
15	15,00	3029	2978,24	71,50	2%
	15,10	2947			
20	20,05	3939	4035,26	150,59	4%
	20,05	4152			

Campioni	mg	Area
1	0,6	47,4
2	1,2	80,4
3	0,6	63,3
4	1,2	74,5
5	1,8	160,6
6	2,4	202,7
7	1,8	163,8
8	2,4	215,4
9	6,0	544,5
10	6,1	565,2
11	8,0	771,0
12	8,0	776,6
13	12,0	1107,2
14	12,0	1094,6
15	20,1	1880,8
16	20,0	2015,6
17	30,0	3028,8
18	30,2	2947,2
19	40,1	3938,6
20	40,1	4152,1

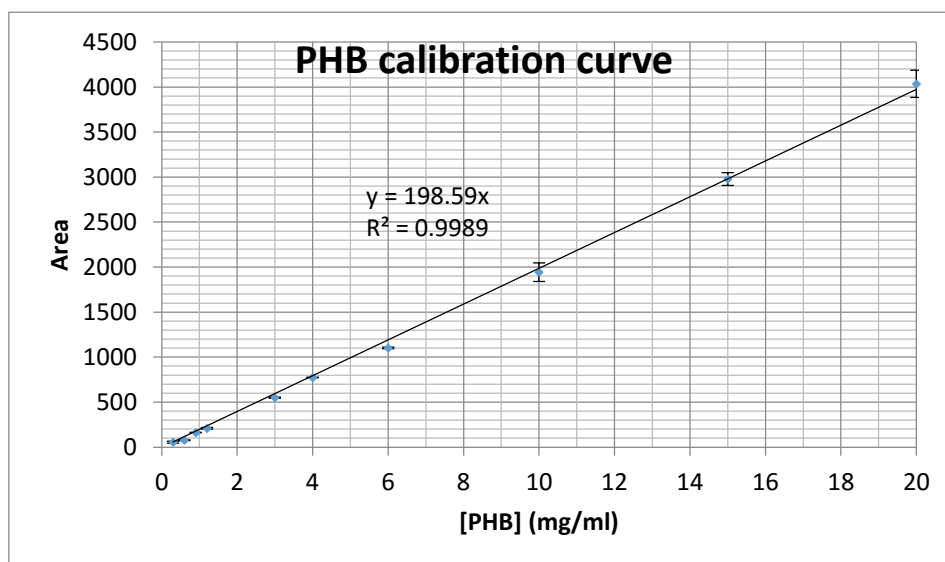
**Conclusions and observations:**

The proportional constant is similar to that found in the previous calibration, which was done in the same conditions as this one: 189.21 against 198.59 the last one obtained.

In the table with the results it can be seen that the highest standard deviation was for 0.3mgPHB/ml $\pm 20\%$. This situation can be improved if a higher volume injection is applied (i.e. 2 μ l).

The proportional constant is near to that one obtained for the 2hydroxyisobutyrate acid methylated on the first experiment performed using an internal standard. In that experiment it was detected that the acid methyl ester has a retention time of 3.2min and a calibration proportional constant of 206.27. For a methyl ester which can be identified but without having a calibration curve of it, a proportional value of 200aprox can be used.

Some picks where identified at the end of the chromatograms, picks that have linear relation with the PHB added for the methanolysis. Maybe these picks are some other monomers (impurities) that were methylated. To corroborate this, it is needed to use the method called PROVAjan which has a long ramp that allow a good picks separation for methyl esters with long retention time.

It was observed that the area value for the benzoic acid methyl ester was constant at 500 approximately with some points that were near 580. It is thought that these values belong to vials prepared with the lasts ml of chloroform, no mix had been performed during its addition and so was concentrated. I remember I finished two bottles of chloroform solution, but I don't remember exactly when I finished *bottle 1* of chloroform solution and starts to use *bottle 2*. But I remember that the last vial was prepared with pure chloroform (without benzoic acid). From the graph It seems that this happened at sample number 9 and 10 from the first bottle; and at samples 17,18 and 19 from the second bottle.

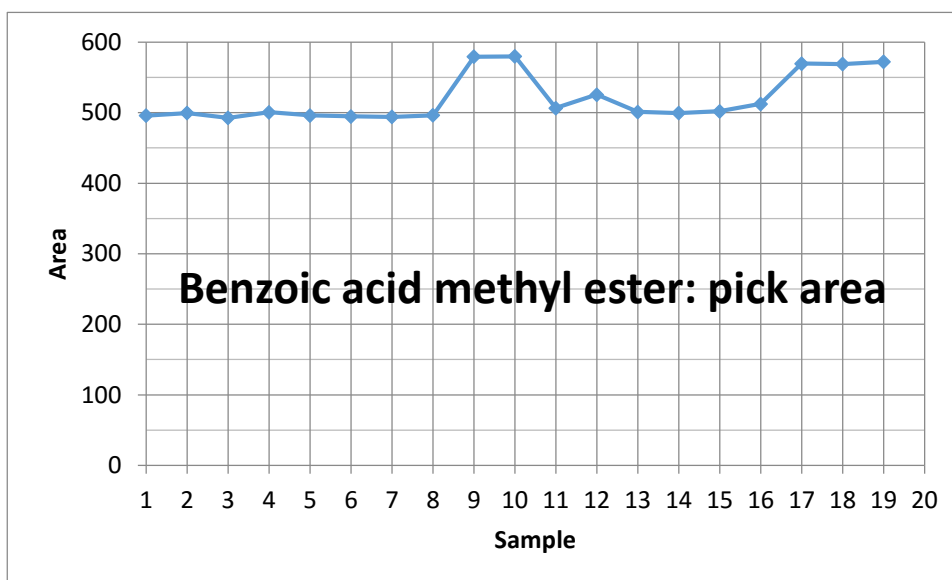

Comparing the area values for the internal standard with the previous obtained for biomass methanolysis kinetic experiment it can be seen that the media in this case (500) is lower than the previous (550-600). Two reasons were thought for this: 1- inaccuracy on the preparation of the chloroform-Benzoic acid solution, small variations on the added amount of acid can be seen on the GC as a proportional variation of the correspond pick area value; 2- a variation on the

added amount of chloroform solution with the micropipette, which will be seen as a proportional variation of the correspond pick area value also.

- 4- *Option 2:* Prepare the necessary amount of test tubes with 20mg of standard PHB, perform the methanolysis in each of them and once the reaction is complete and the extraction was done perform different dilutions to perform de calibration Area vs. concentration.

CALIBRATION USING A STANDARD METHYL ESTER

- 5- It can be compared the signal acquired for the calibration using the standard PHB and the one using the standard methyl ester, same quantities measured in molar concentration: 1mol of monomer in the PHB = 1mol of the methyl ester. In this way the methanolysis process is checked.

CONDITIONS

The same mix as when the methanolysis has to be performed will be used. This is in order not to modify the partitioning coefficient.

Standards to be used:

- 6- Methyl 3-hydroxyhexanoate $C_7H_{14}O_3$ (C6 + C1)
- 7- 2- hydroxyisobutiric acid $C_4H_8O_3$ (C4 + C1)
- 8- Methyl R -3 hydroxyvalerate $C_6H_{12}O_3$ (C5 + C1)
- 9- 3-hydroxydecanoic acid $C_{10}H_{20}O_3$ (C10 + C1)

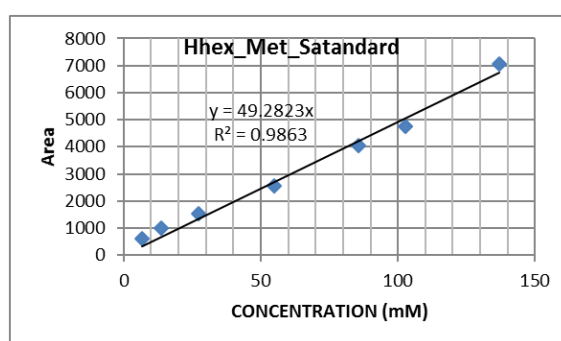
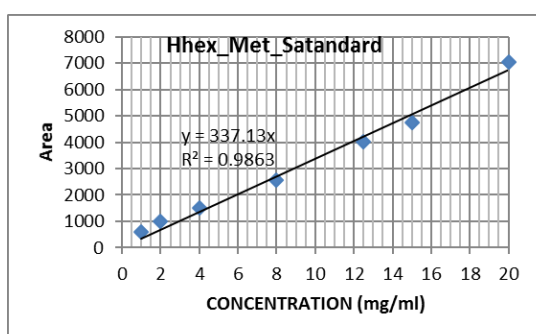

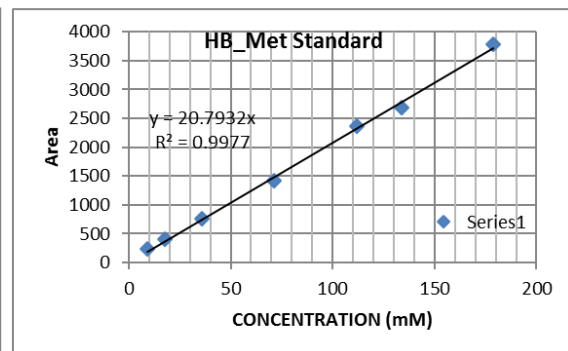
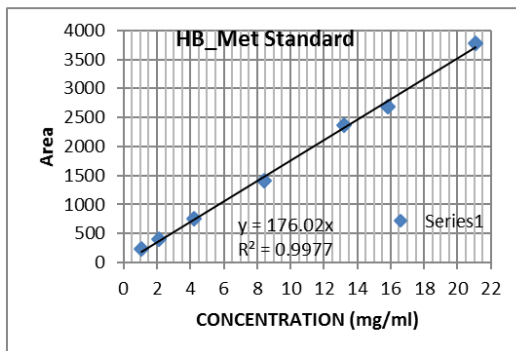
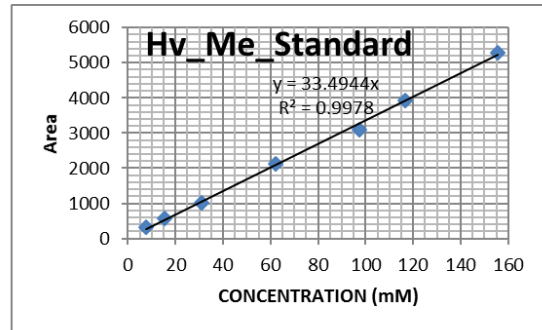
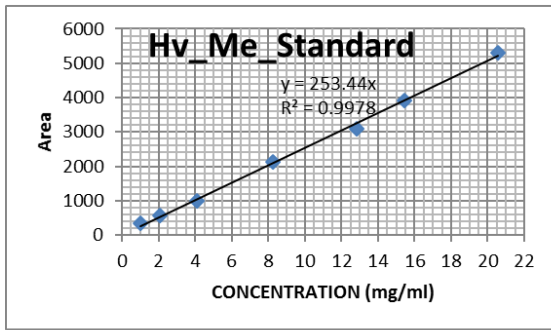

8.1.3 Methanolysis-GC Treated biomass linearity

Aims:

- 1- To see the optimum amount of our cultured *Ralstonia eutropha* (ATCC 17697) dry cell to be used for methanolysis-GC analysis.
- 2- To compare with the results obtained with the lyophilized cells from Portugal (See next graph).

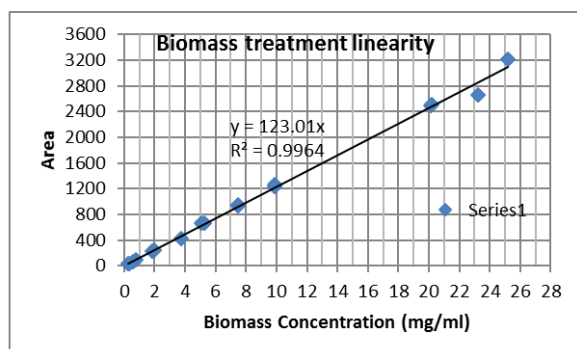
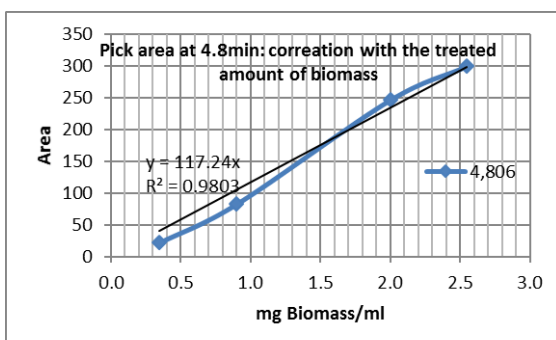

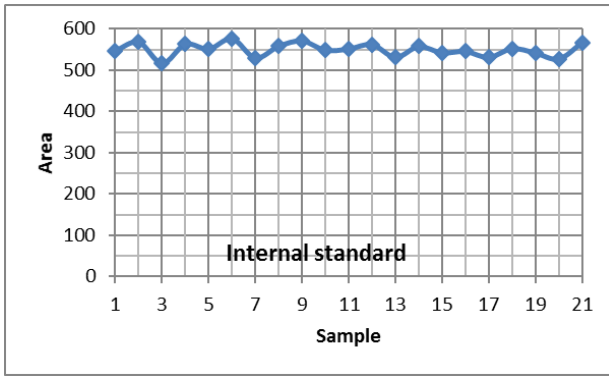

9 REFERENCES

- [1] D.F.M.-W. Manuela Crank, BE Chem Patel, Dr. Martin, D.J. Schleich, D.B. Hüsing, D.G. Angerer, Techno-economic Feasibility of Largescale Production of Bio-based Polymers in Europe, 2005. doi:LF-NA-22103-EN-C ISBN: 92-79-01230-4.
- [2] J. Choi, S.Y. Lee, Factors affecting the economics of polyhydroxyalkanoate production by bacterial fermentation, *Appl Microbiol Biotechnol.* 51 (1999) 13–21. doi:10.1007/s002530051357.
- [3] G.A. Martinez, L. Bertin, A. Scoma, S. Rebecchi, G. Braunegg, F. Fava, Production of polyhydroxyalkanoates from dephenolised and fermented olive mill wastewaters by employing a pure culture of *Cupriavidus necator*, *Biochem. Eng. J.* 97 (2015) 92–100. doi:http://dx.doi.org/10.1016/j.bej.2015.02.015.
- [4] S.Y. Lee, Bacterial polyhydroxyalkanoates, *Biotechnol. Bioeng.* 49 (1996) 1–14. doi:10.1002/(sici)1097-0290(19960105)49:1<1::aid-bit1>3.0.co;2-p.
- [5] G. Braunegg, G. Lefebvre, K.F. Genser, Polyhydroxyalkanoates, biopolyesters from renewable resources: Physiological and engineering aspects, *J Biotechnol.* 65 (1998) 127–161. doi:http://dx.doi.org/10.1016/S0168-1656(98)00126-6.
- [6] K. Sudesh, H. Abe, Y. Doi, Synthesis, structure and properties of polyhydroxyalkanoates: biological polyesters, *Prog. Polym. Sci.* 25 (2000) 1503–1555. doi:http://dx.doi.org/10.1016/S0079-6700(00)00035-6.
- [7] C.S.K. Reddy, R. Ghai, Rashmi, V.C. Kalia, Polyhydroxyalkanoates: an overview, *Bioresour Technol.* 87 (2003) 137–146. doi:http://dx.doi.org/10.1016/S0960-8524(02)00212-2.
- [8] Y.B. Kim, R.W. Lenz, Polyesters from microorganisms, *Adv Biochem Eng Biotechnol.* 71 (2001) 51–79.
- [9] P.J. Barham, A. Keller, E.L. Otun, P.A. Holmes, Crystallization and morphology of a bacterial thermoplastic: poly-3-hydroxybutyrate, *J. Mater. Sci.* 19 (1984) 2781–2794. doi:10.1007/bf01026954.
- [10] G.-Q. Chen, Plastics Completely Synthesized by Bacteria: Polyhydroxyalkanoates, in: G.G.-Q. Chen (Ed.), *Plast. from Bact.*, Springer Berlin Heidelberg, 2010: pp. 17–37. doi:10.1007/978-3-642-03287-5_2.
- [11] M. Koller, A. Atlić, M. Dias, A. Reiterer, G. Braunegg, Microbial PHA Production from Waste Raw Materials, in: G.G.-Q. Chen (Ed.), *Plast. from Bact.*, Springer Berlin Heidelberg, 2010: pp. 85–119. doi:10.1007/978-3-642-03287-5_5.
- [12] R.A. Verlinden, D.J. Hill, M.A. Kenward, C.D. Williams, Z. Piotrowska-Seget, I.K. Radecka, Production of polyhydroxyalkanoates from waste frying oil by *Cupriavidus necator*, *AMB Express.* 1 (2011) 11. doi:10.1186/2191-0855-1-11.
- [13] M. Ali Hassan, Y. Shirai, N. Kusubayashi, M. Ismail Abdul Karim, K. Nakanishi, K. Hasimoto, The production of polyhydroxyalkanoate from anaerobically treated palm oil mill effluent by *Rhodobacter sphaeroides*, *J. Ferment. Bioeng.* 83 (1997) 485–488. doi:http://dx.doi.org/10.1016/S0922-338X(97)83007-3.
- [14] M.G.E. Albuquerque, M. Eiroa, C. Torres, B.R. Nunes, M.A.M. Reis, Strategies for the development of a side stream process for polyhydroxyalkanoate (PHA) production from sugar cane molasses, *J Biotechnol.* 130 (2007) 411–421. doi:http://dx.doi.org/10.1016/j.jbiotec.2007.05.011.

- [15] M. Koller, R. Bona, G. Braunegg, C. Hermann, P. Horvat, M. Kroutil, et al., Production of Polyhydroxyalkanoates from Agricultural Waste and Surplus Materials†, *Biomacromolecules*. 6 (2005) 561–565. doi:10.1021/bm049478b.
- [16] M. Beccari, L. Bertin, D. Dionisi, F. Fava, S. Lampis, M. Majone, et al., Exploiting olive oil mill effluents as a renewable resource for production of biodegradable polymers through a combined anaerobic-aerobic process, *J. Chem. Technol. Biotechnol.* 84 (2009) 901–908. doi:10.1002/jctb.2173.
- [17] J.M.B.T. Cavalheiro, M.C.M.D. de Almeida, C. Grandfils, M.M.R. da Fonseca, Poly(3-hydroxybutyrate) production by *Cupriavidus necator* using waste glycerol, *Process Biochem.* 44 (2009) 509–515. doi:http://dx.doi.org/10.1016/j.procbio.2009.01.008.
- [18] M. Majone, P. Massanisso, A. Carucci, K. Lindrea, V. Tandoi, Influence of storage on kinetic selection to control aerobic filamentous bulking, *Water Sci. Technol.* 34 (1996) 223–232. doi:http://dx.doi.org/10.1016/0273-1223(96)00649-X.
- [19] J.L. Ienczak, W. Schmidell, G.M. Aragao, High-cell-density culture strategies for polyhydroxyalkanoate production: a review, *J Ind Microbiol Biotechnol.* 40 (2013) 275–286. doi:10.1007/s10295-013-1236-z.
- [20] J.A. Albuquerque, J. González, D. García, J. Cegarra, Agrochemical characterisation of “alperujo”, a solid by-product of the two-phase centrifugation method for olive oil extraction, *Bioresour. Technol.* 91 (2004) 195–200. doi:http://dx.doi.org/10.1016/S0960-8524(03)00177-9.
- [21] A. Mekki, A. Dhouib, S. Sayadi, Review: Effects of olive mill wastewater application on soil properties and plants growth, *Int. J. Recycl. Org. Waste Agric.* 2 (2013) 1–7. doi:10.1186/2251-7715-2-15.
- [22] L. Bertin, F. Ferri, A. Scoma, L. Marchetti, F. Fava, Recovery of high added value natural polyphenols from actual olive mill wastewater through solid phase extraction, *Chem. Eng. J.* 171 (2011) 1287–1293. doi:10.1016/j.cej.2011.05.056.
- [23] A. Scoma, L. Bertin, G. Zanaroli, S. Fraraccio, F. Fava, A physicochemical-biotechnological approach for an integrated valorization of olive mill wastewater, *Bioresour Technol.* 102 (2011) 10273–10279. doi:10.1016/j.biortech.2011.08.080.
- [24] J.M. Park, Y.-S. Jang, T.Y. Kim, S.Y. Lee, Development of a gene knockout system for *Ralstonia eutropha* H16 based on the broad-host-range vector expressing a mobile group II intron, *FEMS Microbiol. Lett.* 309 (2010) 193–200. doi:10.1111/j.1574-6968.2010.02041.x.
- [25] H. Brandl, R.A. Gross, R.W. Lenz, R.C. Fuller, *Pseudomonas oleovorans* as a Source of Poly(β -Hydroxyalkanoates) for Potential Applications as Biodegradable Polyesters, *Appl. Environ. Microbiol.* 54 (1988) 1977–1982. http://aem.asm.org/content/54/8/1977.abstract.
- [26] G.Q. Chen, A microbial polyhydroxyalkanoates (PHA) based bio- and materials industry, *Chem Soc Rev.* 38 (2009) 2434–2446.
- [27] D. Frascari, A.E.M. Bacca, F. Zama, L. Bertin, F. Fava, D. Pinelli, Olive mill wastewater valorisation through phenolic compounds adsorption in a continuous flow column, *Chem. Eng. J.* 283 (2016) 293–303. doi:http://dx.doi.org/10.1016/j.cej.2015.07.048.
- [28] F. Raposo, V. Fernández-Cegrí, M.A. De la Rubia, R. Borja, F. Béline, C. Cavinato, et al., Biochemical methane potential (BMP) of solid organic substrates: evaluation of

- anaerobic biodegradability using data from an international interlaboratory study, *J. Chem. Technol. Biotechnol.* 86 (2011) 1088–1098. doi:10.1002/jctb.2622.
- [29] F. Raposo, M.A. De la Rubia, V. Fernández-Cegri, R. Borja, Anaerobic digestion of solid organic substrates in batch mode: An overview relating to methane yields and experimental procedures, *Renew. Sustain. Energy Rev.* 16 (2012) 861–877. doi:http://dx.doi.org/10.1016/j.rser.2011.09.008.
- [30] A. Muhr, E.M. Rechberger, A. Salerno, A. Reiterer, M. Schiller, M. Kwiecień, et al., Biodegradable latexes from animal-derived waste: Biosynthesis and characterization of mcl-PHA accumulated by *Ps. citronellolis*, *React. Funct. Polym.* 73 (2013) 1391–1398. doi:http://dx.doi.org/10.1016/j.reactfunctpolym.2012.12.009.
- [31] S. Le Meur, M. Zinn, T. Egli, L. Thony-Meyer, Q. Ren, Production of medium-chain-length polyhydroxyalkanoates by sequential feeding of xylose and octanoic acid in engineered *Pseudomonas putida* KT2440, *BMC Biotechnol.* 12 (2012) 53. http://www.biomedcentral.com/1472-6750/12/53.
- [32] S. Le Meur, M. Zinn, T. Egli, L. Thony-Meyer, Q. Ren, Poly(4-hydroxybutyrate) (P4HB) production in recombinant *Escherichia coli*: P4HB synthesis is uncoupled with cell growth, *Microb Cell Fact.* 12 (2013) 123. http://www.microbialcellfactories.com/content/12/1/123.
- [33] S. Bengtsson, A. Werker, M. Christensson, T. Welander, Production of polyhydroxyalkanoates by activated sludge treating a paper mill wastewater, *Bioresour Technol.* 99 (2008) 509–516. doi:10.1016/j.biortech.2007.01.020.
- [34] G. Braunegg, B. Sonnleitner, R.M. Lafferty, A rapid gas chromatographic method for the determination of poly- β -hydroxybutyric acid in microbial biomass, *Eur. J. Appl. Microbiol. Biotechnol.* 6 (1978) 29–37. doi:10.1007/bf00500854.
- [35] V.L. Singleton, R. Orthofer, R.M. Lamuela-Raventós, [14] Analysis of total phenols and other oxidation substrates and antioxidants by means of folin-ciocalteu reagent, in: P. Lester (Ed.), *Methods Enzymol.*, Academic Press, 1999: pp. 152–178. doi:http://dx.doi.org/10.1016/S0076-6879(99)99017-1.
- [36] P. Kahar, T. Tsuge, K. Taguchi, Y. Doi, High yield production of polyhydroxyalkanoates from soybean oil by *Ralstonia eutropha* and its recombinant strain, *Polym. Degrad. Stab.* 83 (2004) 79–86. doi:10.1016/s0141-3910(03)00227-1.
- [37] J.W. Holder, J.C. Ulrich, A.C. DeBono, P.A. Godfrey, C.A. Desjardins, J. Zucker, et al., Comparative and functional genomics of *Rhodococcus opacus* PD630 for biofuels development, *PLoS Genet.* 7 (2011) 8.
- [38] Y.H. Yang, C.J. Brigham, C.F. Budde, P. Boccazzi, L.B. Willis, M.A. Hassan, et al., Optimization of growth media components for polyhydroxyalkanoate (PHA) production from organic acids by *Ralstonia eutropha*, *Appl Microbiol Biotechnol.* 87 (2010) 2037–2045. doi:10.1007/s00253-010-2699-8.
- [39] A. Nickzad, A. Mogharei, A. Monazzami, H. Jamshidian, F. Vahabzadeh, Biodegradation of phenol by *Ralstonia eutropha* in a Kissiris-immobilized cell bioreactor, *Water Env. Res.* 84 (2012) 626–634.
- [40] S.L. Riedel, J. Bader, C.J. Brigham, C.F. Budde, Z.A.M. Yusof, C. Rha, et al., Production of poly(3-hydroxybutyrate-co-3-hydroxyhexanoate) by *Ralstonia eutropha* in high cell density palm oil fermentations, *Biotechnol. Bioeng.* 109 (2012) 74–83.

- doi:10.1002/bit.23283.
- [41] M. Zinn, B. Witholt, T. Egli, Occurrence, synthesis and medical application of bacterial polyhydroxyalkanoate, *Adv. Drug Deliv. Rev.* 53 (2001) 5–21. doi:[http://dx.doi.org/10.1016/S0169-409X\(01\)00218-6](http://dx.doi.org/10.1016/S0169-409X(01)00218-6).
- [42] G. Lefebvre, M. Rocher, G. Braunegg, Effects of Low Dissolved-Oxygen Concentrations on Poly-(3-Hydroxybutyrate-co-3-Hydroxyvalerate) Production by *Alcaligenes eutrophus*, *Appl. Environ. Microbiol.* 63 (1997) 827–833. <http://aem.asm.org/content/63/3/827.abstract>.
- [43] D. Léonard, N.D. Lindley, Growth of *Ralstonia eutropha* on inhibitory concentrations of phenol: diminished growth can be attributed to hydrophobic perturbation of phenol hydroxylase activity, *Enzyme Microb. Technol.* 25 (1999) 271–277. doi:[http://dx.doi.org/10.1016/S0141-0229\(99\)00039-3](http://dx.doi.org/10.1016/S0141-0229(99)00039-3).
- [44] D. Leonard, C.B. Youssef, C. Destruhaut, N.D. Lindley, I. Queinnec, Phenol degradation by *Ralstonia eutropha*: colorimetric determination of 2-hydroxymuconate semialdehyde accumulation to control feed strategy in fed-batch fermentations, *Biotechnol Bioeng.* 65 (1999) 407–415.
- [45] J. Yu, J. Wang, Metabolic flux modeling of detoxification of acetic acid by *Ralstonia eutropha* at slightly alkaline pH levels, *Biotechnol. Bioeng.* 73 (2001) 458–464. doi:10.1002/bit.1080.
- [46] J.H. Kim, B.G. Kim, C.Y. Choi, Effect of propionic acid on poly (β -hydroxybutyric-co- β -hydroxyvaleric) acid production by *Alcaligenes eutrophus*, *Biotechnol Lett.* 14 (1992) 903–906. doi:10.1007/bf01020626.
- [47] J. Wang, J. Yu, Kinetic analysis on inhibited growth and poly(3-hydroxybutyrate) formation of *Alcaligenes eutrophus* on acetate under nutrient-rich conditions, *Process Biochem.* 36 (2000) 201–207. doi:[http://dx.doi.org/10.1016/S0032-9592\(00\)00169-2](http://dx.doi.org/10.1016/S0032-9592(00)00169-2).
- [48] E. Jalilnejad, A. Mogharei, F. Vahabzadeh, Aerobic pretreatment of olive oil mill wastewater using *Ralstonia eutropha*, *Env. Technol.* 32 (2011) 1085–1093.
- [49] T. Yamane, Yield of poly-D(-)-3-hydroxybutyrate from various carbon sources: A theoretical study, *Biotechnol. Bioeng.* 41 (1993) 165–170. doi:10.1002/bit.260410122.
- [50] H. Shi, M. Shiraishi, K. Shimizu, Metabolic flux analysis for biosynthesis of poly(β -hydroxybutyric acid) in *Alcaligenes eutrophus* from various carbon sources, *J. Ferment. Bioeng.* 84 (1997) 579–587. doi:[http://dx.doi.org/10.1016/S0922-338X\(97\)81915-0](http://dx.doi.org/10.1016/S0922-338X(97)81915-0).
- [51] D. Dionisi, G. Carucci, M.P. Papini, C. Riccardi, M. Majone, F. Carrasco, Olive oil mill effluents as a feedstock for production of biodegradable polymers, *Water Res.* 39 (2005) 2076–2084. doi:10.1016/j.watres.2005.03.011.
- [52] K.J. Ganzeveld, A. van Hagen, M.H. van Agteren, W. de Koning, A.J.M. Schoot Uiterkamp, Upgrading of organic waste: production of the copolymer poly-3-hydroxybutyrate-co-valerate by *Ralstonia eutrophus* with organic waste as sole carbon source, *J. Clean. Prod.* 7 (1999) 413–419. doi:[http://dx.doi.org/10.1016/S0959-6526\(99\)00159-6](http://dx.doi.org/10.1016/S0959-6526(99)00159-6).
- [53] F. Cerrone, M. Sanchez-Peinado Mdel, B. Juarez-Jimenez, J. Gonzalez-Lopez, C. Pozo, Biological treatment of two-phase olive mill wastewater (TPOMW, alpeorujo): polyhydroxyalkanoates (PHAs) production by *Azotobacter* strains, *J Microbiol Biotechnol.* 20 (2010) 594–601.

- [54] W.S. Lee, A.S.M. Chua, H.K. Yeoh, G.C. Ngoh, A review of the production and applications of waste-derived volatile fatty acids, *Chem. Eng. J.* 235 (2014) 83–99. doi:<http://dx.doi.org/10.1016/j.cej.2013.09.002>.
- [55] S. Bengtsson, J. Hallquist, A. Werker, T. Welander, Acidogenic fermentation of industrial wastewaters: Effects of chemostat retention time and pH on volatile fatty acids production, *Biochem. Eng. J.* 40 (2008) 492–499. doi:<http://dx.doi.org/10.1016/j.bej.2008.02.004>.
- [56] C. Pozo, M. V Martínez-Toledo, B. Rodelas, J. González-López, Effects of culture conditions on the production of polyhydroxyalkanoates by *Azotobacter chroococcum* H23 in media containing a high concentration of alpechín (wastewater from olive oil mills) as primary carbon source, *J Biotechnol.* 97 (2002) 125–131. doi:[http://dx.doi.org/10.1016/S0168-1656\(02\)00056-1](http://dx.doi.org/10.1016/S0168-1656(02)00056-1).
- [57] A. ElMekawy, L. Diels, L. Bertin, H. De Wever, D. Pant, Potential biovalorization techniques for olive mill biorefinery wastewater, *Biofuels, Bioprod. Biorefining.* 8 (2014) 283–293. doi:10.1002/bbb.1450.
- [58] G.A. Martinez, S. Rebecchi, D. Decorti, J.M.B. Domingos, A. Natolino, D. Del Rio, et al., Towards multi-purpose biorefinery platforms for the valorisation of red grape pomace: production of polyphenols, volatile fatty acids, polyhydroxyalkanoates and biogas, *Green Chem.* 18 (2016) 261–270. doi:10.1039/C5GC01558H.
- [59] OIV, State of Vitiviniculture World Market 2015, International Organisation of Vine and Wine - Intergovernmental Organisation, 2015. <http://www.oiv.int/oiv/info/enconjoncture>.
- [60] C. Da Porto, A. Natolino, D. Decorti, Extraction of proanthocyanidins from grape marc by supercritical fluid extraction using CO₂ as solvent and ethanol–water mixture as co-solvent, *J. Supercrit. Fluids.* 87 (2014) 59–64. doi:<http://dx.doi.org/10.1016/j.supflu.2013.12.013>.
- [61] I.I. Rockenbach, E. Rodrigues, L.V. Gonzaga, V. Caliani, M.I. Genovese, A.E. de S.S. Gonçalves, et al., Phenolic compounds content and antioxidant activity in pomace from selected red grapes (*Vitis vinifera* L. and *Vitis labrusca* L.) widely produced in Brazil, *Food Chem.* 127 (2011) 174–179. doi:<http://dx.doi.org/10.1016/j.foodchem.2010.12.137>.
- [62] F. Cherubini, The biorefinery concept: Using biomass instead of oil for producing energy and chemicals, *Energy Convers. Manag.* 51 (2010) 1412–1421. doi:<http://dx.doi.org/10.1016/j.enconman.2010.01.015>.
- [63] A. Scoma, S. Rebecchi, L. Bertin, F. Fava, High impact biowastes from South European agro-industries as feedstock for second-generation biorefineries, *Crit. Rev. Biotechnol.* (2014) 1–15. doi:10.3109/07388551.2014.947238.
- [64] J. Yu, M. Ahmedna, Functional components of grape pomace: their composition, biological properties and potential applications, *Int. J. Food Sci. Technol.* 48 (2013) 221–237. doi:10.1111/j.1365-2621.2012.03197.x.
- [65] E. Dinuccio, P. Balsari, F. Gioelli, S. Menardo, Evaluation of the biogas productivity potential of some Italian agro-industrial biomasses, *Bioresour Technol.* 101 (2010) 3780–3783. doi:<http://dx.doi.org/10.1016/j.biortech.2009.12.113>.
- [66] A. Fabbri, G. Bonifazi, S. Serranti, Micro-scale energy valorization of grape marcs in

- winery production plants, *Waste Manag.* 36 (2015) 156–165.
doi:<http://dx.doi.org/10.1016/j.wasman.2014.11.022>.
- [67] S. Rebecchi, L. Bertin, V. Vallini, G. Bucchi, F. Bartocci, F. Fava, et al., Biomethane production from grape pomaces: a technical feasibility study., in: *ECOMONDO 2013. 17th Int. Trade Fair Mater. Energy Recover. Sustain. Dev.* Rimini, Italy, 6-9 Novemb. 2013., Department of Environmental Engineering and Management, Gh. Asachi Technical University, 2013: pp. 105–108.
<http://www.cabdirect.org/abstracts/20143131254.html;jsessionid=7A8AEBEBFBEE197C881C53E176D9AC?freeview=true#> (accessed January 18, 2016).
- [68] M.T. Agler, B.A. Wrenn, S.H. Zinder, L.T. Angenent, Waste to bioproduct conversion with undefined mixed cultures: the carboxylate platform, *Trends Biotechnol.* 29 (2011) 70–78. doi:<http://dx.doi.org/10.1016/j.tibtech.2010.11.006>.
- [69] M.G. Albuquerque, S. Concas, S. Bengtsson, M.A. Reis, Mixed culture polyhydroxyalkanoates production from sugar molasses: the use of a 2-stage CSTR system for culture selection, *Bioresour Technol.* 101 (2010) 7123–7133.
doi:10.1016/j.biortech.2010.04.019.
- [70] N.P. Povh, M.O.M. Marques, M.A.A. Meireles, Supercritical CO₂ extraction of essential oil and oleoresin from chamomile (*Chamomilla recutita* [L.] Rauschert), *J. Supercrit. Fluids.* 21 (2001) 245–256. doi:[http://dx.doi.org/10.1016/S0896-8446\(01\)00096-1](http://dx.doi.org/10.1016/S0896-8446(01)00096-1).
- [71] H. Sovová, M. Zarevúcka, M. Vacek, K. Stránský, Solubility of two vegetable oils in supercritical CO₂, *J. Supercrit. Fluids.* 20 (2001) 15–28.
doi:[http://dx.doi.org/10.1016/S0896-8446\(01\)00057-2](http://dx.doi.org/10.1016/S0896-8446(01)00057-2).
- [72] S.-P. Ouyang, R.C. Luo, S.-S. Chen, Q. Liu, A. Chung, Q. Wu, et al., Production of Polyhydroxyalkanoates with High 3-Hydroxydodecanoate Monomer Content by *fadB* and *fadA* Knockout Mutant of *Pseudomonas putida* KT2442, *Biomacromolecules.* 8 (2007) 2504–2511. doi:10.1021/bm0702307.
- [73] L. Yu, J. Perret, M. Harris, J. Wilson, S. Haley, Antioxidant Properties of Bran Extracts from “Akron” Wheat Grown at Different Locations, *J. Agric. Food Chem.* 51 (2003) 1566–1570. doi:10.1021/jf020950z.
- [74] B. Sun, G.P. Belchior, J.M. Ricardo-da-Silva, M.I. Spranger, Isolation and purification of dimeric and trimeric procyanidins from grape seeds, *J. Chromatogr. A.* 841 (1999) 115–121. doi:[http://dx.doi.org/10.1016/S0021-9673\(99\)00281-2](http://dx.doi.org/10.1016/S0021-9673(99)00281-2).
- [75] J.C. Espín, C. Soler-Rivas, H.J. Wichers, Characterization of the Total Free Radical Scavenger Capacity of Vegetable Oils and Oil Fractions Using 2,2-Diphenyl-1-picrylhydrazyl Radical, *J. Agric. Food Chem.* 48 (2000) 648–656. doi:10.1021/jf9908188.
- [76] L. Bresciani, L. Calani, M. Cossu, P. Mena, M. Sayegh, S. Ray, et al., (Poly)phenolic characterization of three food supplements containing 36 different fruits, vegetables and berries, *PharmaNutrition.* 3 (2015) 11–19.
doi:<http://dx.doi.org/10.1016/j.phanu.2015.01.001>.
- [77] A.A. Koutinas, A. Vlysidis, D. Pleissner, N. Kopsahelis, I. Lopez Garcia, I.K. Kookos, et al., Valorization of industrial waste and by-product streams via fermentation for the production of chemicals and biopolymers, *Chem. Soc. Rev.* 43 (2014) 2587–2627.
doi:10.1039/c3cs60293a.
- [78] A. Schievano, F. Adani, L. Buessing, A. Botto, E.N. Casoliba, M. Rossoni, et al., An

- integrated biorefinery concept for olive mill waste management: supercritical CO₂ extraction and energy recovery, *Green Chem.* 17 (2015) 2874–2887. doi:10.1039/C5GC00076A.
- [79] A.M. Farías-Campomanes, M.A. Rostagno, M.A.A. Meireles, Production of polyphenol extracts from grape bagasse using supercritical fluids: Yield, extract composition and economic evaluation, *J. Supercrit. Fluids.* 77 (2013) 70–78. doi:http://dx.doi.org/10.1016/j.supflu.2013.02.006.
- [80] J.-M. Souquet, V. Cheynier, F. Brossaud, M. Moutounet, Polymeric proanthocyanidins from grape skins, *Phytochemistry.* 43 (1996) 509–512. doi:http://dx.doi.org/10.1016/0031-9422(96)00301-9.
- [81] D. Del Rio, A. Rodriguez-Mateos, J.P.E. Spencer, M. Tognolini, G. Borges, A. Crozier, Dietary (Poly)phenolics in Human Health: Structures, Bioavailability, and Evidence of Protective Effects Against Chronic Diseases, *Antioxid. Redox Signal.* 18 (2012) 1818–1892. doi:10.1089/ars.2012.4581.
- [82] M. Clifford, D. Rio, Bioavailability of Dietary Monomeric and Polymeric Flavan-3-ols, in: *Flavonoids Relat. Compd.*, CRC Press, 2012. doi:doi:10.1201/b11872-3.
- [83] K. Lappa, P. Kandyliis, N. Bastas, S. Klaoudatos, N. Athanasopoulos, A. Bekatorou, et al., New generation biofuel: continuous acidogenesis of sucrose-raffinose mixture simulating vinasse is promoted by gamma-alumina pellets, *Biotechnol. Biofuels.* 8 (2015) 74. http://www.biotechnologyforbiofuels.com/content/8/1/74.
- [84] C. Dimou, N. Kopsahelis, A. Papadaki, S. Papanikolaou, I.K. Kookos, I. Mandala, et al., Wine lees valorization: Biorefinery development including production of a generic fermentation feedstock employed for poly(3-hydroxybutyrate) synthesis, *Food Res. Int.* 73 (2015) 81–87. doi:http://dx.doi.org/10.1016/j.foodres.2015.02.020.
- [85] S. Follonier, M.S. Goyder, A.-C. Silvestri, S. Crelier, F. Kalman, R. Riesen, et al., Fruit pomace and waste frying oil as sustainable resources for the bioproduction of medium-chain-length polyhydroxyalkanoates, *Int. J. Biol. Macromol.* 71 (2014) 42–52. doi:http://dx.doi.org/10.1016/j.ijbiomac.2014.05.061.
- [86] W. Ahn, S. Park, S. Lee, Production of poly(3-hydroxybutyrate) from whey by cell recycle fed-batch culture of recombinant *Escherichia coli*, *Biotechnol Lett.* 23 (2001) 235–240. doi:10.1023/a:1005633418161.
- [87] J. Choi, S.Y. Lee, High-Level Production of Poly(3-Hydroxybutyrate-co-3-Hydroxyvalerate) by Fed-Batch Culture of Recombinant *Escherichia coli*, *Appl. Environ. Microbiol.* 65 (1999) 4363–4368. http://www.ncbi.nlm.nih.gov/pmc/articles/PMC91579/.
- [88] M. Monti, A. Scoma, G. Martinez, L. Bertin, F. Fava, Uncoupled hydrogen and volatile fatty acids generation in a two-step biotechnological anaerobic process fed with actual site wastewater, *N Biotechnol.* 32 (2015) 341–346. doi:http://dx.doi.org/10.1016/j.nbt.2014.08.002.
- [89] Z. Sun, J.A. Ramsay, M. Guay, B. Ramsay, Increasing the yield of MCL-PHA from nonanoic acid by co-feeding glucose during the PHA accumulation stage in two-stage fed-batch fermentations of *Pseudomonas putida* KT2440., *J. Biotechnol.* 132 (2007) 280–2. doi:10.1016/j.jbiotec.2007.02.023.
- [90] S. Follonier, S. Panke, M. Zinn, A reduction in growth rate of *Pseudomonas putida*

- KT2442 counteracts productivity advances in medium-chain-length polyhydroxyalkanoate production from gluconate, *Microb. Cell Fact.* 10 (2011) 1–11. doi:10.1186/1475-2859-10-25.
- [91] H. Wang, X. Zhou, Q. Liu, G.-Q. Chen, Biosynthesis of polyhydroxyalkanoate homopolymers by *Pseudomonas putida*, *Appl Microbiol Biotechnol.* 89 (2011) 1497–1507. doi:10.1007/s00253-010-2964-x.
- [92] J.-H. Choi, K. Fukushi, K. Yamamoto, A study on the removal of organic acids from wastewaters using nanofiltration membranes, *Sep. Purif. Technol.* 59 (2008) 17–25. doi:http://dx.doi.org/10.1016/j.seppur.2007.05.021.
- [93] Y.-H. Weng, H.-J. Wei, T.-Y. Tsai, W.-H. Chen, T.-Y. Wei, W.-S. Hwang, et al., Separation of acetic acid from xylose by nanofiltration, *Sep. Purif. Technol.* 67 (2009) 95–102. doi:http://dx.doi.org/10.1016/j.seppur.2009.03.030.
- [94] H. Ozaki, H. Li, Rejection of organic compounds by ultra-low pressure reverse osmosis membrane, *Water Res.* 36 (2002) 123–130. doi:http://dx.doi.org/10.1016/S0043-1354(01)00197-X.
- [95] I.S. Han, M. Cheryan, Nanofiltration of model acetate solutions, *J. Memb. Sci.* 107 (1995) 107–113. doi:http://dx.doi.org/10.1016/0376-7388(95)00107-N.
- [96] E. Morin Couallier, B. Salgado Ruiz, M.-L. Lameloise, M. Decloux, Usefulness of reverse osmosis in the treatment of condensates arising from the concentration of distillery vinasses, *Desalination.* 196 (2006) 306–317. doi:http://dx.doi.org/10.1016/j.desal.2006.02.002.
- [97] C. Sagne, C. Fargues, R. Lewandowski, M.-L. Lameloise, M. Decloux, Screening of reverse osmosis membranes for the treatment and reuse of distillery condensates into alcoholic fermentation, *Desalination.* 219 (2008) 335–347. doi:http://dx.doi.org/10.1016/j.desal.2007.05.020.
- [98] C. Sagne, C. Fargues, R. Lewandowski, M.-L. Lameloise, M. Gavach, M. Decloux, A pilot scale study of reverse osmosis for the purification of condensate arising from distillery stillage concentration plant, *Chem. Eng. Process. Process Intensif.* 49 (2010) 331–339. doi:http://dx.doi.org/10.1016/j.cep.2010.03.002.
- [99] M. Rodríguez, S. Luque, J. Alvarez, J. Coca, A comparative study of reverse osmosis and freeze concentration for the removal of valeric acid from wastewaters, *Desalination.* 127 (2000) 1–11. doi:http://dx.doi.org/10.1016/S0011-9164(99)00187-3.
- [100] F. Zhou, C. Wang, J. Wei, Separation of acetic acid from monosaccharides by NF and RO membranes: Performance comparison, *J. Memb. Sci.* 429 (2013) 243–251. doi:http://dx.doi.org/10.1016/j.memsci.2012.11.043.
- [101] S.R. Alberto Scoma Lorenzo Bertin & Fabio Fava, High impact biowastes from South European agro-industries as feedstock for second generation biorefineries, *Crit. Rev. Biotechnol.* (2014). doi:DOI:10.3109/07388551.2014.947238.
- [102] O. Folin, V. Ciocalteu, ON TYROSINE AND TRYPTOPHANE DETERMINATIONS IN PROTEINS, *J. Biol. Chem.* 73 (1927) 627–650. http://www.jbc.org/content/73/2/627.short.
- [103] L. Bertin, S. Lampis, D. Todaro, A. Scoma, G. Vallini, L. Marchetti, et al., Anaerobic acidogenic digestion of olive mill wastewaters in biofilm reactors packed with ceramic filters or granular activated carbon, *Water Res.* 44 (2010) 4537–4549.

doi:10.1016/j.watres.2010.06.025.

- [104] PlasticsEurope - Latest publications - PlasticsEurope, (n.d.).
<http://www.plasticseurope.org/information-centre/publications.aspx> (accessed March 30, 2016).
- [105] BIO-TIC is a FP7 European-funded project on Industrial Biotechnology, (n.d.).
<http://www.industrialbiotech-europe.eu/bio-tic/deliverables/> (accessed March 30, 2016).